



Intel[®] Celeron[®] Processor Specification Update

Release Date: September 2002

Document Number: 243748-047

The Intel[®] Celeron[®] processor may contain design defects or errors known as errata, which may cause the product to deviate from published specifications. Current characterized errata are documented in this Specification Update.

Information in this document is provided in connection with Intel® products. No license, express or implied, by estoppel or otherwise, to any intellectual property rights is granted by this document. Except as provided in Intel's Terms and Conditions of Sale for such products, Intel assumes no liability whatsoever, and Intel disclaims any express or implied warranty, relating to sale and/or use of Intel products including liability or warranties relating to fitness for particular purpose, merchantability or infringement or any patent, copyright or other intellectual property right. Intel products are not intended for use in medical, life saving, or life sustaining applications.

Intel may make changes to specifications and product descriptions at any time, without notice.

Designers must not rely on the absence or characteristics of any features or instructions marked "reserved" or "undefined." Intel reserves these for future definition and shall have no responsibility whatsoever for conflicts or incompatibilities arising from future changes to them.

The Celeron processor may contain design defects or errors known as errata which may cause the product to deviate from published specifications. Current characterized errata are available on request.

Contact your local Intel sales office or your distributor to obtain the latest specifications and before placing your product order.

Copies of documents which have an ordering number and are referenced in this document, or other Intel literature, may be obtained by calling 1-800-548-4725 or by visiting Intel's website at <http://www.intel.com>

*Other names and brands may be claimed as the property of others.

Intel, Celeron, Pentium, Pentium II Xeon, Pentium III Xeon, Intel Pentium, MMX, and the Intel logo are trademarks or registered trademarks of Intel Corporation or its subsidiaries in the United States and other countries.

Copyright © 1998–2002, Intel Corporation

CONTENTS

REVISION HISTORY.....	ii
PREFACE	v
Specification Update for the Intel® Celeron® Processor	1
GENERAL INFORMATION.....	1
Intel® Celeron® Processor and Boxed Intel® Celeron® Processor Markings (S.E.P. Package)	1
Intel® Celeron® Processor and Boxed Intel® Celeron® Processor Markings (PPGA Package)	2
Intel® Celeron® Processor and Boxed Intel® Celeron® Processor Markings (FC-PGA/FC-PGA2 Package)	3
IDENTIFICATION INFORMATION	4
SUMMARY OF CHANGES.....	10
ERRATA.....	22
DOCUMENTATION CHANGES.....	66
SPECIFICATION CLARIFICATIONS.....	85
SPECIFICATION CHANGES.....	87

REVISION HISTORY

Date of Revision	Version	Description
April 1998	-001	This document is the first Specification Update for the Intel® Celeron® processor.
May 1998	-002	Added Errata 24 through 28.
June 1998	-003	Updated S-spec Table. Updated Summary Table of Changes. Updated Erratum 2 and 26. Added Errata 29 and 30. Added Documentation Changes 7 through 12. Added Specification Clarification 6 and 7.
July 1998	-004	Updated S-spec Table. Added Documentation Changes 13 through 16. Added Specification Clarifications 7 through 12. Added Specification Change 1.
August 1998	-005	Updated Summary Table of Changes. Changed numbering in order to maintain consistency with other product Specification Updates. Updated Errata 6 and 38. Added Errata 56 through 59. Updated Specification Clarification 5.
September 1998	-006	Updated S-spec table. Updated Erratum 56. Added Errata 60 through 62.
October 1998	-007	Implemented new numbering nomenclature. Updated Errata C1 and C27. Added Errata C37 through C39. Added Specification Clarification C15. Added Specification Change C2.
November 1998	-008	Updated Erratum C23. Added Erratum C40. Updated Documentation Change C10. Added Documentation Changes C17 and C18. Added Specification Change C3.
December 1998	-009	Added the Celeron processor (PPGA) markings. Added the Mb0 stepping to the Processor Identification Information table and the Table of Changes. Added Errata C41 and C42.
December 1998	-010	Updated Identification Information table
January 1999	-011	Added Erratum C3AP. Added Documentation Changes C19 and C20. Updated Processor Identification Information table.
February 1999	-012	Updated Processor Identification Information table.
March 1999	-013	Updated Processor Markings, Summary Table of Changes, Documentation Changes, Specification Clarifications, and Specification Changes sections. Added Specification Change C1.
May 1999	-014	Updated the Processor Identification Information table. Added Erratum C43.
June 1999	-015	Added Erratum C44. Added Documentation Change C1. Added Specification Clarifications C2 and C3. Added Specification Change C1.
July 1999	-016	Added Erratum C45.

**REVISION HISTORY**

Date of Revision	Version	Description
August 1999	-017	Added Documentation Change C2. Updated Preface paragraph. Updated Codes Used in Summary Table. Updated column heading in Errata, Documentation Changes, Specification Clarifications and Specification Changes tables.
October 1999	-018	Added 'Brand Id' to <i>Identification Information</i> table. Updated <i>Processor Identification Information</i> Table. Added Errata C46.
November 1999	-019	Added Errata C47 and C48. Added Documentation Change C3.
December 1999	-020	Added Errata C49. Added Documentation Change C4. Added Specification Clarification C4.
January 2000	-021	Added Errata C50 and C51. Added Documentation Change C5.
February 2000	-022	Added Documentation Change C6. Updated Summary of Changes product letter codes.
March 2000	-023	Updated Erratum C47. Updated the CPUID/Stepping information in the Summary of Changes section.
May 2000	-024	Updated the <i>Intel® Celeron® Processor Identification Information</i> table. Added Errata C52 – C69. Updated the <i>Summary of Errata</i> , <i>Summary of Documentation Changes</i> , <i>Summary of Specification Clarifications</i> and <i>Summary of Changes</i> tables. Added Specification Change C2.
June 2000	-025	Added Specification Change C3.
July 2000	-026	Added Errata C70 and C71.
August 2000	-027	Updated Processor Identification Information table. Added Erratum C72.
September 2000	-028	Updated the <i>Intel® Celeron® Processor Identification Information</i> table. Added Erratum C73. Updated Errata C33 ,C47 and C51. Added Documentation changes C7 and C8.
October 2000	-029	Added Erratum C74. Added Documentation Changes C9 and C10
November 2000	-030	Updated the <i>Intel® Celeron® Processor Identification Information</i> table Added Errata C75 and C76.
December 2000	-031	Updated Specification Update product key to include the Intel® Pentium® 4 processor, Updated Erratum C2. Added Documentation changes C11, C12, C13, C14, C15 and C16.
January 2001	-032	Updated the <i>Intel® Celeron® Processor Identification Information</i> table, Updated Erratum C2. Added Documentation changes C17 and C18.
February 2001	-033	Updated Documentation change C17. Added Documentation change C19.
March 2001	-034	Updated <i>Summary of Errata</i> , <i>Summary of Documentation Changes</i> , <i>Summary of Specification Clarifications</i> and <i>Summary of Specification Changes</i> tables. Added Errata C77 and C78.



REVISION HISTORY

Date of Revision	Version	Description
July 2001	-035	Updated the <i>Intel® Celeron® Processor Identification Information</i> table. Updated the Summary of Errata table.
August 2001	-036	Added Errata C79 and C80. Updated the Summary of changes section.
August 2001	-037	Out of cycle release. Updated the <i>Intel® Celeron® Processor Identification Information</i> table
October 2001	-038	Updated the identification information section with 0.13 micron Celeron processor details. Updated Processor Identification Information Table. Updated Summary of Errata Table. Updated Summary of Documentation Changes Table. Updated Summary of Specification Clarifications Table. Updated Summary of Specifications Changes Table. Added Errata C81 and C82.
December 2001	-039	Added Documentation Changes C1, C2, C3, C4 and C5. Updated Processor Identification Information Table.
January 2002	-040	Updated Processor Identification Information Table.
January 2002	-041	Added the 1A and 1.10A GHz specifications.
February 2002	-042	Added the 566 MHz at 1.75 VID specifications.
March 2002	-043	Updated Erratum C79. Added Erratum C83. Added Doc change C1. Updated Processor Identification Information table.
April 2002	-044	Added Documentation change C1
May 2002	-045	Updated Erratum C67. Added Doc changes C1-C3. Updated Processor Identification Information Table.
July 2002	-046	Added erratum C84. Added Documentation Changes C1 - C12. Added/updated CPUID 0x6B4 processor.
September 2002	-047	Updated Processor Identification Information Table. Updated Summary of Errata Table. Added Documentation Changes C3 – C24.



PREFACE

This document is an update to the specifications contained in the following documents:

- *Pentium® II Processor Developer's Manual* (Order Number 243502)
- *P6 Family of Processors Hardware Developer's Manual* (Order Number 244001)
- *Intel® Celeron® Processor Datasheet* (Document Number 243658)
- *Intel Architecture Software Developer's Manual, Volumes 1, 2, and 3* (Order Numbers 245470, 245471, and 245472, respectively)

It is intended for hardware system manufacturers and software developers of applications, operating systems, or tools. It contains S-Specs, Errata, Documentation Changes, Specification Clarifications and, Specification Changes.

Nomenclature

S-Spec Number is a five-digit code used to identify products. Products are differentiated by their unique characteristics, e.g., core speed, L2 cache size, package type, etc. as described in the processor identification information table. Care should be taken to read all notes associated with each S-Spec number.

Errata are design defects or errors. Errata may cause the Celeron processor's behavior to deviate from published specifications. Hardware and software designed to be used with any given processor must assume that all errata documented for that processor are present on all devices unless otherwise noted.

Documentation Changes include typos, errors, or omissions from the current published specifications. These changes will be incorporated in the next release of the specifications.

Specification Clarifications describe a specification in greater detail or further highlight a specification's impact to a complex design situation. These clarifications will be incorporated in the next release of the specifications.

Specification Changes are modifications to the current published specifications for the Celeron processor. These changes will be incorporated in the next release of the specifications.

Specification Update for the Intel® Celeron® Processor

GENERAL INFORMATION

Intel® Celeron® Processor and Boxed Intel® Celeron® Processor Markings (S.E.P. Package)

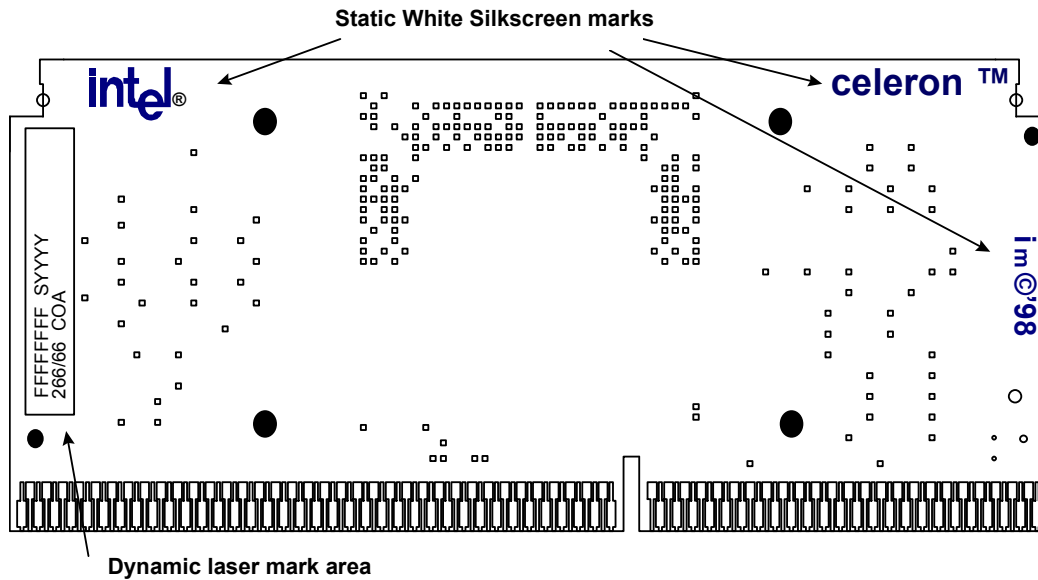

NOTES:

- SYYYY = S-spec Number.
- FFFFFFFF = FPO # (Test Lot Traceability #).
- COA = Country of Assembly.

Intel® Celeron® Processor and Boxed Intel® Celeron® Processor Markings (PPGA Package)

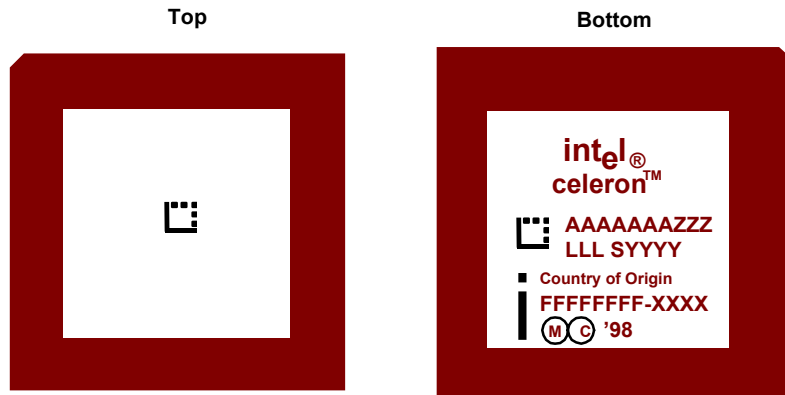

NOTES:

- AAAAAAA = Product Code
- ZZZ = Processor Speed (MHz)
- LLL = Integrated Level-Two Cache Size (in Kilobytes)
- SYYYY = S-Spec Number
- FFFFFFFF-XXXX = Assembly Lot Tracking Number

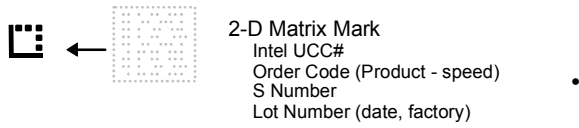

Intel® Celeron® Processor and Boxed Intel® Celeron® Processor Markings (FC-PGA/FC-PGA2 Package)

FC-PGA 370 Pin Package

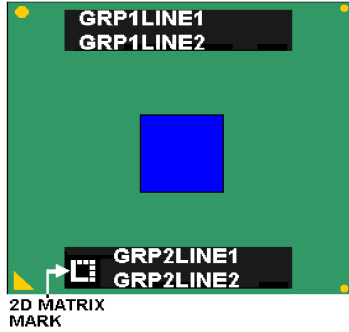

GRP1LN1: INTEL (m)(c) '01_ _{COO}
 GRP1LN2: {Core Freq}/{Cache}/{Bus Freq}/{Voltage}

GRP2LN1: {FPO}-{S/N}
 GRP2LN2: CELERON {S-Spec}

FC-PGA2 370 Pin Package

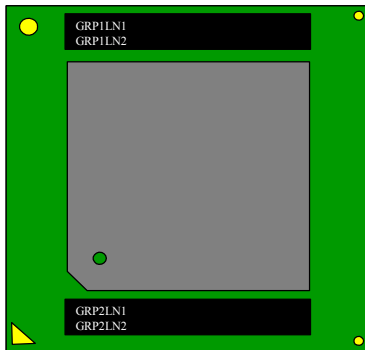

GRP1LN1: INTEL (m)(c) '01_ _{Country of Origin}
 GRP1LN2: {Core freq}/{Cache}/{Bus Freq}/{Voltage}

GRP2LN1: {FPO}-{S/N}
 GRP2LN2: CELERON {S-Spec}



IDENTIFICATION INFORMATION

Complete identification information of the Celeron processor can be found in the *Intel Processor Identification and the CPUID Instruction* application note (Document Number 241618).

The Celeron processor can be identified by the following values:

Family ¹	Model ²	Brand ID ³
0110	0101	00h = Not Supported
0110	0110	00h = Not Supported
0110	1000	01h = "Intel® Celeron® Processor"
0110	1011 ⁴	03h = "Intel® Celeron® Processor"

NOTES:

1. The Family corresponds to bits [11:8] of the EDX register after RESET, bits [11:8] of the EAX register after the CPUID instruction is executed with a 1 in the EAX register, and the generation field of the Device ID register accessible through Boundary Scan.
2. The Model corresponds to bits [7:4] of the EDX register after RESET, bits [7:4] of the EAX register after the CPUID instruction is executed with a 1 in the EAX register, and the model field of the Device ID register accessible through Boundary Scan.
3. The Brand ID corresponds to bits [7:0] of the EBX register after the CPUID instruction is executed with a 1 in the EAX register.
4. This only applies to units with processor signature of 0x6B1.

The Celeron processor's second level (L2) cache size can be determined by the following register contents:

0-Kbyte Unified L2 Cache¹	40h
128-Kbyte Unified L2 Cache¹	41h
256-Kbyte 8 way set associative 32byte line size, L2 Cache¹	82h

NOTE:

1. When the EAX register contains a value of 2, the CPUID instruction loads the EAX, EBX, ECX and EDX registers with descriptors that indicate the processors cache and TLB characteristics. The lower 8 bits of the EAX register (AL) contain a value that identifies the number of times the CPUID has to be executed to obtain a complete image of the processor's caching systems. The remainder of the EAX register, the EBX, ECX and EDX registers contain the cache and TLB descriptors. When bit 31 in a given register is zero, that register contains valid 8-bit descriptors. To decode descriptors, move sequentially from the most significant byte of the register down through the least significant byte of the register. Assuming bit 31 is 0, then that register contains valid cache or TLB descriptors in bits 24 through 31, bits 16 through 23, bits 8 through 15 and bits 0 through 7. Software must compare the value contained in each of the descriptor bit fields according to the definition of the CPUID instruction. For more details refer to the *AP-485 Intel Processor Identification and the CPUID Instruction Application Note*.



Intel® Celeron® Processor Identification Information

S-Spec	Core Stepping	L2 Cache Size (Kbytes)	CPUID	Speed (MHz) Core/Bus	Package and Revision	Notes
SL2SY	A0	0	0650h	266/66	SEPP Rev. 1	
SL2YN	A0	0	0650h	266/66	SEPP Rev. 1	1
SL2YP	A0	0	0650h	300/66	SEPP Rev. 1	
SL2Z7	A0	0	0650h	300/66	SEPP Rev. 1	1
SL2TR	A1	0	0651h	266/66	SEPP Rev. 1	
SL2QG	A1	0	0651h	266/66	SEPP Rev. 1	1
SL2X8	A1	0	0651h	300/66	SEPP Rev. 1	
SL2Y2	A1	0	0651h	300/66	SEPP Rev. 1	1
SL2Y3	B0	0	0652h	266/66	SEPP Rev. 1	1
SL2Y4	B0	0	0652h	300/66	SEPP Rev. 1	1
SL2WM	A0	128	0660h	300A/66	SEPP Rev. 1	3
SL32A	A0	128	0660h	300A/66	SEPP Rev. 1	1
SL2WN	A0	128	0660h	333/66	SEPP Rev. 1	3
SL32B	A0	128	0660h	333/66	SEPP Rev. 1	1
SL376	A0	128	0660h	366/66	SEPP Rev. 1	
SL37Q	A0	128	0660h	366/66	SEPP Rev. 1	1
SL39Z	A0	128	0660h	400/66	SEPP Rev. 1	
SL37V	A0	128	0660h	400/66	SEPP Rev. 1	1
SL3BC	A0	128	0660h	433/66	SEPP Rev. 1	
SL35Q	B0	128	0665h	300A/66	PPGA	2
SL36A	B0	128	0665h	300A/66	PPGA	18
SL35R	B0	128	0665h	333/66	PPGA	2
SL36B	B0	128	0665h	333/66	PPGA	
SL36C	B0	128	0665h	366/66	PPGA	
SL35S	B0	128	0665h	366/66	PPGA	2
SL3A2	B0	128	0665h	400/66	PPGA	
SL37X	B0	128	0665h	400/66	PPGA	2
SL3BA	B0	128	0665h	433/66	PPGA	
SL3BS	B0	128	0665h	433/66	PPGA	2



Intel® Celeron® Processor Identification Information

S-Spec	Core Stepping	L2 Cache Size (Kbytes)	CPUID	Speed (MHz) Core/Bus	Package and Revision	Notes
SL3EH	B0	128	0665h	466/66	PPGA	
SL3FL	B0	128	0665h	466/66	PPGA	2
SL3FY	B0	128	0665h	500/66	PPGA	
SL3LQ	B0	128	0665h	500/66	PPGA	2
SL3FZ	B0	128	0665h	533/66	PPGA	
SL3PZ	B0	128	0665h	533/66	PPGA	2
SL46S	B0	128	0683h	533A/66	FC-PGA	
SL3W6	B0	128	0683h	533A/66	FC-PGA	2
SL46T	B0	128	0683h	566/66	FC-PGA	
SL3W7	B0	128	0683h	566/66	FC-PGA	2
SL4PC	C0	128	0686h	566/66	FC-PGA	2, 7, 5
SL4NW	C0	128	0686h	566/66	FC-PGA	2, 7, 5
SL5L5	D0	128	068Ah	566/66	FC-PGA	7, 8
SL46U	B0	128	0683h	600/66	FC-PGA	
SL3W8	B0	128	0683h	600/66	FC-PGA	2
SL4PB	C0	128	0686h	600/66	FC-PGA	2, 7, 5
SL4NX	C0	128	0686h	600/66	FC-PGA	2, 7, 5
SL3VS	B0	128	0683h	633/66	FC-PGA	
SL3W9	B0	128	0683h	633/66	FC-PGA	2
SL4PA	C0	128	0686h	633/66	FC-PGA	2, 6, 5
SL4NY	C0	128	0686h	633/66	FC-PGA	2, 6, 5
SL48E	B0	128	0683h	667/66	FC-PGA	
SL4AB	B0	128	0683h	667/66	FC-PGA	2
SL4P9	C0	128	0686h	667/66	FC-PGA	2, 6, 5
SL4NZ	C0	128	0686h	667/66	FC-PGA	2, 6, 5
SL48F	B0	128	0683h	700/66	FC-PGA	
SL4EG	B0	128	0683h	700/66	FC-PGA	2
SL4P8	C0	128	0686h	700/66	FC-PGA	2, 4, 5
SL4P2	C0	128	0686h	700/66	FC-PGA	2, 4, 5



Intel® Celeron® Processor Identification Information

S-Spec	Core Stepping	L2 Cache Size (Kbytes)	CPUID	Speed (MHz) Core/Bus	Package and Revision	Notes
SL4P7	C0	128	0686h	733/66	FC-PGA	4, 5
SL4P3	C0	128	0686h	733/66	FC-PGA	2, 4, 5
SL52Y	D0	128	068Ah	733/66	FC-PGA	4, 8
SL5E9	D0	128	068Ah	733/66	FC-PGA	2, 4, 8
SL4P6	C0	128	0686h	766/66	FC-PGA	4, 5
SL4QF	C0	128	0686h	766/66	FC-PGA	2, 4, 5
SL52X	D0	128	068Ah	766/66	FC-PGA	4, 8
SL5EA	D0	128	068Ah	766/66	FC-PGA	2, 4, 8
SL4TF	C0	128	0686h	800/100	FC-PGA	4, 5
SL45R	C0	128	0686h	800/100	FC-PGA	2, 4, 5
SL54P	D0	128	068Ah	800/100	FC-PGA	4, 8
SL5WC	D0	128	068Ah	800/100	FC-PGA	4, 8
SL5EB	D0	128	068Ah	800/100	FC-PGA	2, 4, 8
SL5WW	D0	128	068Ah	800/100	FC-PGA	2, 4, 8
SL5GA	C0	128	0686h	850/100	FC-PGA	4, 5
SL5GB	C0	128	0686h	850/100	FC-PGA	2, 4, 5
SL54Q	D0	128	068Ah	850/100	FC-PGA	4, 8
SL5EC	D0	128	068Ah	850/100	FC-PGA	2, 4, 8
SL5LX	D0	128	068Ah	900/100	FC-PGA	8, 9
SL5WA	D0	128	068Ah	900/100	FC-PGA	8, 9
SL5MQ	D0	128	068Ah	900/100	FC-PGA	2, 8, 9
SL5WY	D0	128	068Ah	900/100	FC-PGA	2, 8, 9
SL633	D0	128	068Ah	900/100	FC-PGA2	2,8,14
SL5UZ	D0	128	068Ah	950/100	FC-PGA	8, 10
SL5V2	D0	128	068Ah	950/100	FC-PGA	2, 8, 10
SL634	D0	128	068Ah	950/100	FC-PGA2	2,8,14



Intel® Celeron® Processor Identification Information

S-Spec	Core Stepping	L2 Cache Size (Kbytes)	CPUID	Speed (MHz) Core/Bus	Package and Revision	Notes
SL5XT	D0	128	068Ah	1 GHz/100	FC-PGA	8, 11
SL5XQ	D0	128	068Ah	1 GHz/100	FC-PGA	2, 8, 11
SL635	D0	128	068Ah	1 GHz/100	FC-PGA2	2, 8, 13
SL5ZF	A1	256	06B1h	1A GHz/100	FC-PGA2	2, 12, 13
SL5VP	A1	256	06B1h	1A GHz/100	FC-PGA2	2, 12, 13
SL6CB	B1	256	06B4h	1A GHz/100	FC-PGA2	13, 15
SL6JQ	B1	256	06B4h	1A GHz/100	FC-PGA2	2, 13, 15
SL5XU	D0	128	068Ah	1.10 GHz/100	FC-PGA	8, 9
SL5XR	D0	128	068Ah	1.10 GHz/100	FC-PGA	2, 8, 9
SL5VQ	A1	256	06B1h	1.10A GHz/100	FC-PGA2	2, 12, 13
SL5ZE	A1	256	06B1h	1.10A GHz/100	FC-PGA2	2, 12, 13
SL6CA	B1	256	06B4h	1.10A GHz/100	FC-PGA2	13, 15
SL6JR	B1	256	06B4h	1.10A GHz/100	FC-PGA2	2, 13, 15
SL5XS	A1	256	06B1h	1.20 GHz/100	FC-PGA2	12, 13
SL5Y5	A1	256	06B1h	1.20 GHz/100	FC-PGA2	2, 12, 13
SL656	A1	256	06B1h	1.20 GHz/100	FC-PGA2	15, 17
SL68P	A1	256	06B1h	1.20 GHz/100	FC-PGA2	2, 15, 17
SL6C8	B1	256	06B4h	1.20 GHz/100	FC-PGA2	15, 17
SL6JS	B1	256	06B4h	1.20 GHz/100	FC-PGA2	2, 15, 17
SL5VR	A1	256	06B1h	1.30 GHz/100	FC-PGA2	15, 16
SL5ZJ	A1	256	06B1h	1.30 GHz/100	FC-PGA2	2, 15, 16
SL6C7	B1	256	06B4h	1.30 GHz/100	FC-PGA2	15, 16



Intel® Celeron® Processor Identification Information

S-Spec	Core Stepping	L2 Cache Size (Kbytes)	CPUID	Speed (MHz) Core/Bus	Package and Revision	Notes
SL6JT	B1	256	06B4h	1.30 GHz/100	FC-PGA2	2, 15, 16
SL64V	A1	256	06B1h	1.40 GHz/100	FC-PGA2	14, 15
SL68G	A1	256	06B1h	1.40 GHz/100	FC-PGA2	2, 14, 15
SL6C6	B1	256	06B4h	1.40 GHz/100	FC-PGA2	14, 15
SL6JU	B1	256	06B4h	1.40 GHz/100	FC-PGA2	2, 14, 15

NOTES:

1. This is a boxed Celeron processor with an attached fan heatsink.
2. This is a boxed Celeron processor with an unattached fan heatsink.
3. This part also ships as a boxed Celeron processor with an attached fan heatsink.
4. This part requires Tj of 80° C.
5. This part uses a V_{CCCORE} of 1.7 V.
6. This part will require Tj of 82C.
7. This part will require Tj of 90C.
8. This part uses a V_{CCCORE} of 1.75 V.
9. This part has max Tj of 77° C.
10. This part has max Tj of 79° C.
11. This part has max Tj of 75° C.
12. This part uses a V_{CCCORE} of 1.475 V.
13. This part has max Tcase of 69 Deg C
14. This part has max Tcase of 72 Deg C
15. This part uses a V_{CCCORE} of 1.5 V.
16. This part has max Tcase of 71 Deg C
17. This part has max Tcase of 70 Deg C
18. This part has min Tcase of 5 deg C, max Tcase of 85 deg C and TDP of 17.8 W,



SUMMARY OF CHANGES

The following table indicates the Errata, Documentation Changes, Specification Clarifications, or Specification Changes that apply to Celeron processors. Intel intends to fix some of the errata in a future stepping of the component, and to account for the other outstanding issues through documentation or specification changes as noted. This table uses the following notations:

X:	Specification Change, Erratum, Specification Clarification, or Documentation Change applies to the given processor stepping.
(No mark) or (blank box):	This item is fixed in or does not apply to the given stepping.
Doc:	Document change or update that will be implemented.
PlanFix:	This erratum may be fixed in a future stepping of the product.
Fixed:	This erratum has been previously fixed.
NoFix:	There are no plans to fix this erratum.
Doc:	Intel intends to update the appropriate documentation in a future revision.
AP:	APIC related erratum.
PKG:	This column refers to errata on the Intel® Celeron® processor substrate.
Shaded:	This item is either new or modified from the previous version of the document.

Each Specification Update item is prefixed with a capital letter to distinguish the product. The key below details the letters that are used in Intel's microprocessor Specification Updates:

A = Intel® Pentium® II processor

B = Mobile Intel® Pentium® II processor

C = Intel® Celeron® processor

D = Intel® Pentium® II Xeon™ processor

E = Intel® Pentium® III processor

G = Intel® Pentium® III Xeon™ processor

H = Mobile Intel® Celeron® processor at 466 MHz, 433 MHz, 400 MHz, 366 MHz, 333 MHz, 300 MHz, and 266 MHz

K = Mobile Intel® Pentium® III processor

M = Mobile Intel® Celeron® processor at 500 MHz, 450 MHz, and 400A MHz

N = Intel® Pentium® 4 processor

O = Intel® Xeon™ processor MP

P = Intel® Xeon™ processor

The Specification Updates for the Pentium processor, Pentium® Pro processor, and other Intel products do not use this convention.



Summary of Errata

NO.	CPUID/Stepping									Plans	ERRATA
	650h A0	651h A1	660h A0	665h B0	683h B0	686h C0	68Ah D0	6B1h A1	6B4h B1		
C1	X	X	X	X	X	X	X	X	X	NoFix	FP Data Operand Pointer may be incorrectly calculated after FP access which wraps 64-Kbyte boundary in 16-bit code
C2	X	X	X	X	X	X	X	X	X	NoFix	Differences exist in debug exception reporting
C3	X	X	X	X	X	X	X	X	X	NoFix	Code fetch matching disabled debug register may cause debug exception
C4	X	X	X	X	X	X	X	X	X	NoFix	FP inexact-result exception flag may not be set
C5	X	X	X	X	X	X	X	X	X	NoFix	BTM for SMI will contain incorrect FROM EIP
C6	X	X	X	X	X	X	X	X	X	NoFix	I/O restart in SMM may fail after simultaneous MCE
C7	X	X	X	X	X	X	X	X	X	NoFix	Branch traps do not function if BTMs are also enabled
C8	X	X	X	X	X	X	X	X	X	NoFix	Machine check exception handler may not always execute successfully
C9	X	X	X	X	X	X	X	X	X	NoFix	LBBER may be corrupted after some events
C10	X	X	X	X	X	X	X	X	X	NoFix	BTMs may be corrupted during simultaneous L1 cache line replacement
C11	X	X	X	X						Fixed	Potential early deassertion of LOCK# during split-lock cycles
C12	X	X	X	X						Fixed	A20M# may be inverted after returning from SMM and Reset
C13	X	X								Fixed	Reporting of floating-point exception may be delayed
C14	X	X	X	X	X	X	X	X	X	NoFix	Near CALL to ESP creates unexpected EIP address
C15	X	X								Fixed	Built-in self test always gives nonzero result
C16	X	X	X	X						Fixed	THERMTRIP# may not be asserted as specified



Summary of Errata

NO.	CUID/Stepping									Plans	ERRATA
	650h A0	651h A1	660h A0	665h B0	683h B0	686h C0	68Ah D0	6B1h A1	6B4h B1		
C17	X									Fixed	Cache state corruption in the presence of page A/D-bit setting and snoop traffic
C18	X									Fixed	Snoop cycle generates spurious machine check exception
C19	X	X								Fixed	MOVD/MOVB instruction writes to memory prematurely
C20	X	X	X	X	X	X	X	X	X	NoFix	Memory type undefined for nonmemory operations
C21	X	X								Fixed	Bus protocol conflict with optimized chipsets
C22	X	X	X	X	X	X	X	X	X	NoFix	FP Data Operand Pointer may not be zero after power on or Reset
C23	X	X	X	X	X	X	X	X	X	NoFix	MOVD following zeroing instruction can cause incorrect result
C24	X	X	X	X	X	X	X	X	X	NoFix	Premature execution of a load operation prior to exception handler invocation
C25	X	X	X	X	X	X	X	X	X	NoFix	Read portion of RMW instruction may execute twice
C26	X	X	X	X						Fixed	Test pin must be high during power up
C27	X	X	X	X		X	X	X	X	Fixed	Intervening writeback may occur during locked transaction
C28	X	X	X	X	X	X	X	X	X	NoFix	MC2_STATUS MSR has model-specific error code and machine check architecture error code reversed
C29	X	X	X	X	X	X	X	X	X	NoFix	MOV with debug register causes debug exception
C30	X	X	X	X	X	X	X	X	X	NoFix	Upper four PAT entries not usable with Mode B or Mode C paging
C31	X	X								Fixed	Incorrect memory type may be used when MTRRs are



Summary of Errata

NO.	CUID/Stepping									Plans	ERRATA
	650h A0	651h A1	660h A0	665h B0	683h B0	686h C0	68Ah D0	6B1h A1	6B4h B1		
											disabled
C32	X	X	X							Fixed	Misprediction in program flow may cause unexpected instruction execution
C33	X	X	X	X	X	X	X	X	X	NoFix	Data Breakpoint Exception in a displacement relative near call may corrupt EIP
C34	X	X	X	X	X	X	X	X	X	NoFix	System bus ECC not functional with 2:1 ratio
C35	X	X	X			X	X	X	X	Fixed	Fault on REP CMPS/SCAS operation may cause incorrect EIP
C36	X	X	X	X	X	X	X			NoFix	RDMSR and WRMSR to invalid MSR address may not cause GP fault
C37	X	X	X	X	X	X	X			NoFix	SYSENTER/SYSEXIT instructions can implicitly load "null segment selector" to SS and CS registers
C38	X	X	X	X	X	X	X			NoFix	PRELOAD followed by EXTEST does not load boundary scan data
C39	X	X	X	X						Fixed	Far jump to new TSS with D-bit cleared may cause system hang
C40	X	X								Fixed	Incorrect chunk ordering may prevent execution of the machine check exception handler after BINIT#
C41	X	X	X							Fixed	UC write may be reordered around a cacheable write
C42	X	X	X	X						Fixed	Resume Flag may not be cleared after debug exception
C43			X	X						Fixed	Internal cache protocol violation may cause system hang
C44	X	X	X	X	X	X	X	X	X	NoFix	GP# fault on WRMSR to ROB_CR_BKUPTMPDR6
C45	X	X	X							Fixed	Machine Check Exception may occur due to improper line eviction in the IFU



Summary of Errata

NO.	CUID/Stepping									Plans	ERRATA
	650h A0	651h A1	660h A0	665h B0	683h B0	686h C0	68Ah D0	6B1h A1	6B4h B1		
C46	X	X	X	X	X	X	X	X	X	NoFix	Lower bits of SMRAM SMBASE register cannot be written with an ITP
C47	X	X	X	X						Fixed	Task switch may cause wrong PTE and PDE access bit to be set
C48	X	X	X	X	X	X	X	X	X	NoFix	Cross-modifying code operations on a jump instruction may cause a general protection fault
C49	X	X	X	X	X					Fixed	Deadlock may occur due to illegal-instruction/page-miss combination
C50	X	X	X	X	X	X	X	X	X	NoFix	FLUSH# assertion following STPCLK# may prevent CPU clocks from stopping
C51	X	X	X	X						Fixed	Floating-point exception condition may be deferred
C52	X	X	X	X	X					Fixed	Cache Line Reads May Result in Eviction of Invalid Data
C53					X	X	X	X	X	NoFix	FLUSH# servicing delayed while waiting for STARTUP_IPI in 2-way MP systems
C54					X	X	X	X	X	NoFix	Double ECC error on read may result in BINIT#
C55					X	X	X	X	X	NoFix	MCE due to L2 parity error gives L1 MCACOD.LL
C56					X	X	X	X	X	NoFix	EFLAGS discrepancy on a page fault after a multiprocessor TLB shutdown
C57					X	X	X	X	X	NoFix	Mixed cacheability of lock variables is problematic in MP systems
C58					X	X	X	X	X	NoFix	INT 1 with DR7.GD set does not clear DR7.GD
C59					X	X	X	X	X	NoFix	Potential loss of data coherency during MP data ownership transfer
C60					X	X	X	X	X	NoFix	Misaligned Locked access to



Summary of Errata

NO.	CPUID/Stepping									Plans	ERRATA
	650h A0	651h A1	660h A0	665h B0	683h B0	686h C0	68Ah D0	6B1h A1	6B4h B1		
											APIC space results in a hang
C61					X	X	X	X	X	NoFix	Memory ordering based synchronization may cause a livelock condition in MP Systems
C62					X	X	X	X	X	NoFix	Processor may assert DRDY# on a write with no data
C63					X					Fixed	Machine check exception may occur due to improper line eviction in the IFU
C65					X	X				NoFix	Snoop request may cause DBSY# hang
C66					X					Fixed	MASKMOVQ instruction interaction with string operation may cause deadlock
C67					X	X	X	X	X	NoFix	MOVD, CVTISI2SS, or PINSRW Following Zeroing Instruction Can Cause Incorrect Result
C68					X					NoFix	Snoop probe during FLUSH# could cause L2 to be left in shared state
C69					X					Fixed*	Livelock May Occur Due to IFU Line Eviction
C70	X	X	X	X	X					Fixed	Selector for the LTR/LLDT register may get corrupted
C71	X	X	X	X	X	X	X	X	X	NoFix	INIT does not clear global entries in the TLB
C72	X	X	X	X	X	X	X	X	X	NoFix	VM bit will be cleared on a double fault handler
C73	X	X	X	X	X	X	X	X	X	NoFix	Memory aliasing with inconsistent A and D bits may cause processor deadlock
C74	X	X	X	X	X	X	X	X	X	NoFix	Processor may report invalid TSS fault instead of Double fault during mode C paging
C75						X	X			Fixed	APIC failure at CPU core/system bus frequency



Summary of Errata

NO.	CUID/Stepping									Plans	ERRATA
	650h A0	651h A1	660h A0	665h B0	683h B0	686h C0	68Ah D0	6B1h A1	6B4h B1		
											of 766/66 MHz
C76	X	X	X	X	X	X	X	X	X	NoFix	Machine check exception may occur when interleaving code between different memory types
C77	X	X	X	X	X	X	X	X	X	NoFix	Wrong ESP Register Values During a Fault in VM86 Mode
C78	X	X	X	X	X	X	X	X	X	NoFix	APIC ICR Write May Cause Interrupt Not to be Sent When ICR Delivery Bit Pending
C79	X	X	X	X	X	X	X	X		Fixed	The instruction fetch unit (IFU) may fetch instructions based upon stale CR3 data after a write to CR3 Register
C80							X			NoFix	Processor Might not Exit Sleep State Properly Upon De-assertion of CPUSLP# Signal
C81								X	X	NoFix	During Boundary Scan, BCLK not Sampled High When SLP# is Asserted Low
C82								X	X	NoFix	Incorrect assertion of THERMTRIP# Signal
C83	X	X	X	X	X	X	X	X	X	NoFix	Under some complex conditions, the Instructions in the shadow of a JMP FAR may be unintentionally executed and retired
C84	X	X	X	X	X	X	X	X	X	NoFix	Processor Does not Flag #GP on Non-zero Write to Certain MSRs
C1AP	X	X	X	X	X	X	X	X	X	NoFix	APIC access to cacheable memory causes SHUTDOWN
C2AP	X	X	X	X	X	X	X	X	X	NoFix	Write to mask LVT (programmed as EXTINT) will not deassert outstanding interrupt
C3AP	X	X	X	X	X	X	X	X	X	NoFix	Misaligned locked access to APIC space results in hang





* Fix will be only on Celeron processors with CPUID=068xh.

Summary of Documentation Changes

NO.	CPUID/Stepping									Plans	DOCUMENTATION CHANGES
	650h A0	651h A1	660h A0	665h B0	683h B0	686h C0	68Ah D0	6B1h A1	6B4h B1		
C1	X	X	X	X	X	X	X	X	X	Doc	SSE and SSE2 Instructions Opcodes
C2	X	X	X	X	X	X	X	X	X	Doc	Executing the SSE2 Variant on a Non-SSE2 Capable Processor
C3	X	X	X	X	X	X	X	X	X	Doc	Direction Flag (DF) Mistakenly Denoted as a System Flag
C4	X	X	X	X	X	X	X	X	X	Doc	Fopcode Compatibility Mode
C5	X	X	X	X	X	X	X	X	X	Doc	FCOS, FPTAN, FSIN, and FSINCOS Trigonometric Domain not correct
C6	X	X	X	X	X	X	X	X	X	Doc	Incorrect Description of stack
C7	X	X	X	X	X	X	X	X	X	Doc	EFLAGS Register Correction
C8	X	X	X	X	X	X	X	X	X	Doc	PSE-36 Paging Mechanism
C9	X	X	X	X	X	X	X	X	X	Doc	0x33 Opcode
C10	X	X	X	X	X	X	X	X	X	Doc	Incorrect Information for SLDT
C11	X	X	X	X	X	X	X	X	X	Doc	LGDT/LIDT Instruction Information Correction
C12	X	X	X	X	X	X	X	X	X	Doc	Errors In Instruction Set Reference
C13	X	X	X	X	X	X	X	X	X	Doc	RSM Instruction Set Summary
C14	X	X	X	X	X	X	X	X	X	Doc	Correct MOVAPS and MOVAPD Operand Section
C15	X	X	X	X	X	X	X	X	X	Doc	DAA—Decimal Adjust AL after Addition
C16	X	X	X	X	X	X	X	X	X	Doc	DAS—Decimal Adjust AL after Subtraction
C17	X	X	X	X	X	X	X	X	X	Doc	Omission of Dependency between BTM and LBR
C18	X	X	X	X	X	X	X	X	X	Doc	I/O Permissions Bitmap Base Addy > 0xDFFF Does not Cause #GP(0) Fault
C19	X	X	X	X	X	X	X	X	X	Doc	Wrong Field Width for MINSS and MAXSS
C20	X	X	X	X	X	X	X	X	X	Doc	Figure 15-12 PEBS Record Format
C21	X	X	X	X	X	X	X	X	X	Doc	I/O Permission Bit Map



Summary of Documentation Changes

NO.	CPUID/Stepping									Plans	DOCUMENTATION CHANGES
	650h A0	651h A1	660h A0	665h B0	683h B0	686h C0	68Ah D0	6B1h A1	6B4h B1		
C22	X	X	X	X	X	X	X	X	X	Doc	Cache Description
C23	X	X	X	X	X	X	X	X	X	Doc	Instruction Formats and Encoding
C24	X	X	X	X	X	X	X	X	X	Doc	Machine-Check Initialization



Summary of Specification Clarifications

NO.	CPUID/Stepping									Plans	SPECIFICATION CLARIFICATIONS
	650h A0	651h A1	660h A0	665h B0	683h B0	686h C0	68Ah D0	6B1h A1	6B4h B1		
C1	X	X	X	X	X	X	X	X	X	Doc	PWRGOOD inactive pulse width
C2	X	X	X	X	X	X	X	X	X	Doc	Floating-point opcode clarification
C3	X	X	X	X	X	X	X	X	X	Doc	MTRR initialization clarification
C4	X	X	X	X	X	X	X	X	X	Doc	Non-AGTL+ output low current clarification



Summary of Specification Changes

NO.	CUID/Stepping									Plans	SPECIFICATION CHANGES
	650h A0	651h A1	660h A0	665h B0	683h B0	686h C0	68Ah D0	6B1h A1	6B4h B1		
C1	X	X	X	X	X	X	X	X	X	Doc	RESET# pin definition
C2					X	X	X			Doc	Tco max revision for 533A,566 & 600MHz
C3					X	X	X	X	X	Doc	Processor thermal specification change and TDP redefined

ERRATA

C1. FP Data Operand Pointer May Be Incorrectly Calculated After FP Access Which Wraps 64-Kbyte Boundary in 16-Bit Code

Problem: The FP Data Operand Pointer is the effective address of the operand associated with the last noncontrol floating-point instruction executed by the machine. If an 80-bit floating-point access (load or store) occurs in a 16-bit mode other than protected mode (in which case the access will produce a segment limit violation), the memory access wraps a 64-Kbyte boundary, and the floating-point environment is subsequently saved, the value contained in the FP Data Operand Pointer may be incorrect.

Implication: A 32-bit operating system running 16-bit floating-point code may encounter this erratum, under the following conditions:

- The operating system is using a segment greater than 64 Kbytes in size.
- An application is running in a 16-bit mode other than protected mode.
- An 80-bit floating-point load or store which wraps the 64-Kbyte boundary is executed.
- The operating system performs a floating-point environment store (FSAVE/FNSAVE/FSTENV/FNSTENV) after the above memory access.
- The operating system uses the value contained in the FP Data Operand Pointer.

Wrapping an 80-bit floating-point load around a segment boundary in this way is not a normal programming practice. Intel has not currently identified any software which exhibits this behavior.

Workaround: If the FP Data Operand Pointer is used in an OS which may run 16-bit floating-point code, care must be taken to ensure that no 80-bit floating-point accesses are wrapped around a 64-Kbyte boundary.

Status: For the steppings affected see the *Summary of Changes* at the beginning of this section.

C2. Differences Exist in Debug Exception Reporting

Problem: There exist some differences in the reporting of code and data breakpoint matches between that specified by previous Celeron processor specifications and the behavior of Celeron processor, as described below:

Case 1: The first case is for a breakpoint set on a MOVSS or POPSS instruction, when the instruction following it causes a debug register protection fault (DR7.gd is already set, enabling the fault). The Celeron processor reports delayed data breakpoint matches from the MOVSS or POPSS instructions by setting the matching DR6.bi bits, along with the debug register protection fault (DR6.bd). If additional breakpoint faults are matched during the call of the debug fault handler, the Celeron processor sets the breakpoint match bits (DR6.bi) to reflect the breakpoints matched by both the MOVSS or POPSS breakpoint and the debug fault handler call. The Celeron processor only sets DR6.bd in either situation, and does not set any of the DR6.bi bits.

Case 2: In the second breakpoint reporting failure case, if a MOVSS or POPSS instruction with a data breakpoint is followed by a store to memory which:

- a) crosses a 4-Kbyte page boundary,

OR

b) causes the page table Access or Dirty (A/D) bits to be modified,

the breakpoint information for the MOVSS or POPSS will be lost. Previous Celeron processors retain this information under these boundary conditions.

Case 3: If they occur after a MOVSS or POPSS instruction, the $INTn$, INTO, and INT3 instructions zero the DR6.bi bits (bits B0 through B3), clearing pending breakpoint information, unlike previous Intel Celeron processors.

Case 4: If a data breakpoint and an SMI (System Management Interrupt) occur simultaneously, the SMI will be serviced via a call to the SMM handler, and the pending breakpoint will be lost.

Case 5: When an instruction that accesses a debug register is executed, and a breakpoint is encountered on the instruction, the breakpoint is reported twice.

Case 6: Unlike previous versions of Intel Architecture processors, Celeron processors will not set the Bi bits for a matching disabled breakpoint unless at least one other breakpoint is enabled.

Implication: When debugging or when developing debuggers for a Pentium III processor-based system, this behavior should be noted. Normal usage of the MOVSS or POPSS instructions (i.e., following them with a MOV ESP) will not exhibit the behavior of cases 1-3. Debugging in conjunction with SMM will be limited by case 4.

Workaround: Following MOVSS and POPSS instructions with a MOV ESP instruction when using breakpoints will avoid the first three cases of this erratum. No workaround has been identified for cases 4 or 5.

Status: For the steppings affected see the *Summary of Changes* at the beginning of this section.

C3. Code Fetch Matching Disabled Debug Register May Cause Debug Exception

Problem: The bits L0-3 and G0-3 enable breakpoints local to a task and global to all tasks, respectively. If one of these bits is set, a breakpoint is enabled, corresponding to the addresses in the debug registers DR0-DR3. If at least one of these breakpoints is enabled, any of these registers are *disabled* (i.e., L_n and G_n are 0), and RW_n for the disabled register is 00 (indicating a breakpoint on instruction execution), normally an instruction fetch will not cause an instruction-breakpoint fault based on a match with the address in the disabled register(s). However, if the address in a disabled register matches the address of a code fetch which also results in a page fault, an instruction-breakpoint fault will occur.

Implication: While debugging software, extraneous instruction-breakpoint faults may be encountered if breakpoint registers are not cleared when they are disabled. Debug software which does not implement a code breakpoint handler will fail, if this occurs. If a handler is present, the fault will be serviced. Mixing data and code may exacerbate this problem by allowing disabled data breakpoint registers to break on an instruction fetch.

Workaround: The debug handler should clear breakpoint registers before they become disabled.

Status: For the steppings affected see the *Summary of Changes* at the beginning of this section.



C4. FP Inexact-Result Exception Flag May Not Be Set

Problem: When the result of a floating-point operation is not exactly representable in the destination format (1/3 in binary form, for example), an inexact-result (precision) exception occurs. When this occurs, the PE bit (bit 5 of the FPU status word) is normally set by the processor. Under certain rare conditions, this bit may not be set when this rounding occurs. However, other actions taken by the processor (invoking the software exception handler if the exception is unmasked) are not affected. This erratum can only occur if the floating-point operation which causes the precision exception is immediately followed by one of the following instructions:

- FST m32real
- FST m64real
- FSTP m32real
- FSTP m64real
- FSTP m80real
- FIST m16int
- FIST m32int
- FISTP m16int
- FISTP m32int
- FISTP m64int

Note that even if this combination of instructions is encountered, there is also a dependency on the internal pipelining and execution state of both instructions in the processor.

Implication: Inexact-result exceptions are commonly masked or ignored by applications, as it happens frequently, and produces a rounded result acceptable to most applications. The PE bit of the FPU status word may not always be set upon receiving an inexact-result exception. Thus, if these exceptions are unmasked, a floating-point error exception handler may not recognize that a precision exception occurred. Note that this is a “sticky” bit, i.e., once set by an inexact-result condition, it remains set until cleared by software.

Workaround: This condition can be avoided by inserting two NOP instructions between the two floating-point instructions.

Status: For the steppings affected see the *Summary of Changes* at the beginning of this section.

C5. BTM for SMI Will Contain Incorrect FROM EIP

Problem: A system management interrupt (SMI) will produce a Branch Trace Message (BTM), if BTMs are enabled. However, the FROM EIP field of the BTM (used to determine the address of the instruction which was being executed when the SMI was serviced) will not have been updated for the SMI, so the field will report the same FROM EIP as the previous BTM.

Implication: A BTM which is issued for an SMI will not contain the correct FROM EIP, limiting the usefulness of BTMs for debugging software in conjunction with System Management Mode (SMM).

Workaround: None identified

Status: For the steppings affected see the *Summary of Changes* at the beginning of this section.

C6. I/O Restart in SMM May Fail After Simultaneous MCE

Problem: If an I/O instruction (IN, INS, REP INS, OUT, OUTS, or REP OUTS) is being executed, and if the data for this instruction becomes corrupted, the Celeron processor will signal a machine check exception (MCE). If the instruction is directed at a device which is powered down, the processor may also receive an assertion of SMI#. Since MCEs have higher priority, the processor will call the MCE handler, and the SMI# assertion will remain pending. However, upon attempting to execute the first instruction of the MCE handler, the SMI# will be recognized and the processor will attempt to execute the SMM handler. If the SMM handler is completed successfully, it will attempt to restart the I/O instruction, but will not have the correct machine state, due to the call to the MCE handler.

Implication: A simultaneous MCE and SMI# assertion may occur for one of the I/O instructions above. The SMM handler may attempt to restart such an I/O instruction, but will have corrupted state due to the MCE handler call, leading to failure of the restart and shutdown of the processor.

Workaround: If a system implementation must support both SMM and MCEs, the first thing the SMM handler code (when an I/O restart is to be performed) should do is check for a pending MCE. If there is an MCE pending, the SMM handler should immediately exit via an RSM instruction and allow the machine check exception handler to execute. If there is not, the SMM handler may proceed with its normal operation.

Status: For the steppings affected see the *Summary of Changes* at the beginning of this section.

C7. Branch Traps Do Not Function If BTMs Are Also Enabled

Problem: If branch traps or branch trace messages (BTMs) are enabled alone, both function as expected. However, if both are enabled, only the BTMs will function, and the branch traps will be ignored.

Implication: The branch traps and branch trace message debugging features cannot be used together.

Workaround: If branch trap functionality is desired, BTMs must be disabled.

Status: For the steppings affected see the *Summary of Changes* at the beginning of this section.

C8. Machine Check Exception Handler May Not Always Execute Successfully

Problem: An asynchronous machine check exception (MCE), such as a BINIT# event, which occurs during an access that splits a 4-Kbyte page boundary may leave some internal registers in an indeterminate state. Thus, MCE handler code may not always run successfully if an asynchronous MCE has occurred previously.

Implication: An MCE may not always result in the successful execution of the MCE handler. However, asynchronous MCEs usually occur upon detection of a catastrophic system condition that would also hang the processor. Leaving MCEs disabled will result in the condition which caused the asynchronous MCE instead causing the processor to enter shutdown. Therefore, leaving MCEs disabled may not improve overall system behavior.

Workaround: No workaround which would guarantee successful MCE handler execution under this condition has been identified.

Status: For the steppings affected see the *Summary of Changes* at the beginning of this section.

C9. LBER May Be Corrupted After Some Events

Problem: The last branch record (LBR) and the last branch before exception record (LBER) can be used to determine the source and destination information for previous branches or exceptions. The LBR contains the source and destination addresses for the last branch or exception, and the LBER contains similar information for the last branch taken before the last exception. This information is typically used to determine the location of a branch which leads to execution of code which causes an exception. However, after a catastrophic bus condition which results in an assertion of BINIT# and the re-initialization of the buses, the value in the LBER may be corrupted. Also, after either a CALL which results in a fault or a software interrupt, the LBER and LBR will be updated to the same value, when the LBER should not have been updated.

Implication: The LBER and LBR registers are used only for debugging purposes. When this erratum occurs, the LBER will not contain reliable address information. The value of LBER should be used with caution when debugging branching code; if the values in the LBR and LBER are the same, then the LBER value is incorrect. Also, the value in the LBER should not be relied upon after a BINIT# event.

Workaround: None identified

Status: For the steppings affected see the *Summary of Changes* at the beginning of this section.

C10. BTMs May Be Corrupted During Simultaneous L1 Cache Line Replacement

Problem: When Branch Trace Messages (BTMs) are enabled and such a message is generated, the BTM may be corrupted when issued to the bus by the L1 cache if a new line of data is brought into the L1 data cache simultaneously. Though the new line being stored in the L1 cache is stored correctly, and no corruption occurs in the data, the information in the BTM may be incorrect due to the internal collision of the data line and the BTM.

Implication: Although BTMs may not be entirely reliable due to this erratum, the conditions necessary for this boundary condition to occur have only been exhibited during focused simulation testing. Intel has currently not observed this erratum in a system level validation environment.

Workaround: None identified

Status: For the steppings affected see the *Summary of Changes* at the beginning of this section.

C11. Potential Early Deassertion of LOCK# During Split-Lock Cycles

Problem: During a split-lock cycle there are four bus transactions: 1st ADS# (a partial read), 2nd ADS# (a partial read), 3rd ADS# (a partial write), and the 4th ADS# (a partial write). Due to this erratum, LOCK# may deassert one clock after the 4th ADS# of the split-lock cycle instead of after the 4th RS# assertion corresponding to the 4th ADS# has been sampled. The following sequence of events are required for this erratum to occur:

1. A lock cycle occurs (split or nonsplit).
2. Five more bus transactions (assertion of ADS#) occur.
3. A split-lock cycle occurs and BNR# toggles after the 3rd ADS# (partial write) of the split-lock cycle. This in turn delays the assertion of the 4th ADS# of the split-lock cycle. BNR# toggling at this time could most likely happen when the bus is set for an IOQ depth of 2.

When all of these events occur, LOCK# will be deasserted in the next clock after the 4th ADS# of the split-lock cycle.

Implication: This may affect chipset logic which monitors the behavior of LOCK# deassertion.

Workaround: None identified

Status: For the steppings affected see the *Summary of Changes* at the beginning of this section.

C12. A20M# May Be Inverted After Returning From SMM and Reset

Problem: This erratum is seen when software causes the following events to occur:

1. The assertion of A20M# in real address mode.
2. After entering the 1-Mbyte address wrap-around mode caused by the assertion of A20M#, there is an assertion of SMI# intended to cause a Reset or remove power to the processor. Once in the SMM handler, software saves the SMM state save map to an area of nonvolatile memory from which it can be restored at some point in the future. Then software asserts RESET# or removes power to the processor.
3. After exiting Reset or completion of power-on, software asserts SMI# again. Once in the SMM handler, it then retrieves the old SMM state save map which was saved in event 2 above and copies it into the current SMM state save map. Software then asserts A20M# and executes the RSM instruction. After exiting the SMM handler, the polarity of A20M# is inverted.

Implication: If this erratum occurs, A20M# will behave with a polarity opposite from what is expected (i.e., the 1-Mbyte address wrap-around mode is enabled when A20M# is deasserted, and does not occur when A20M# is asserted).

Workaround: Software should save the A20M# signal state in nonvolatile memory before an assertion of RESET# or a power down condition. After coming out of Reset or at power on, SMI# should be asserted again. During the restoration of the old SMM state save map described in event 3 above, the entire map should be restored, except for bit 5 of the byte at offset 7F18h. This bit should retain the value assigned to it when the SMM state save map was created in event 3. The SMM handler should then restore the original value of the A20M# signal.

Status: For the steppings affected see the *Summary of Changes* at the beginning of this section.

C13. Reporting of Floating-Point Exception May Be Delayed

Problem: The Celeron processor normally reports a floating-point exception for an instruction when the next floating-point or Intel® MMX™ technology instruction is executed. The assertion of FERR# and/or the INT 16 interrupt corresponding to the exception may be delayed until the floating-point or MMX technology instruction *after* the one which is expected to trigger the exception, if the following conditions are met:

1. A floating-point instruction causes an exception.
2. Before another floating-point or MMX technology instruction, any one of the following occurs:
 - A subsequent data access occurs to a page which has not been marked as accessed
 - Data is referenced which crosses a page boundary
 - A possible page-fault condition is detected which, when resolved, completes without faulting
3. The instruction causing event 2 above is followed by a MOVQ or MOVD store instruction.

Implication: This erratum only affects software which operates with floating-point exceptions unmasked. Software which requires floating-point exceptions to be visible on the next floating-point or MMX technology instruction, and which uses floating-point calculations on data which is then used for MMX technology instructions, may see a delay in the reporting of a floating-point instruction exception in some cases. Note that mixing floating-point and MMX technology instructions in this way is not recommended.

Workaround: Inserting a WAIT or FWAIT instruction (or reading the floating-point status register) between the floating-point instruction and the MOVQ or MOVD instruction will give the expected results. This is already the recommended practice for software.

Status: For the steppings affected see the *Summary of Changes* at the beginning of this section.

C14. Near CALL to ESP Creates Unexpected EIP Address

Problem: As documented, the CALL instruction saves procedure linking information in the procedure stack and jumps to the called procedure specified with the destination (target) operand. The target operand specifies the address of the first instruction in the called procedure. This operand can be an immediate value, a general purpose register, or a memory location. When accessing an absolute address indirectly using the stack pointer (ESP) as a base register, the base value used is the value in the ESP register before the instruction executes. However, when accessing an absolute address directly using ESP as the base register, the base value used is the value of ESP *after* the return value is pushed on the stack, not the value in the ESP register *before* the instruction executed.

Implication: Due to this erratum, the processor may transfer control to an unintended address. Results are unpredictable, depending on the particular application, and can range from no effect to the unexpected termination of the application due to an exception. Intel has observed this erratum only in a focused testing environment. Intel has not observed any commercially available operating system, application, or compiler that makes use of or generates this instruction.

Workaround: If the other seven general purpose registers are unavailable for use, and it is necessary to do a CALL via the ESP register, first push ESP onto the stack, then perform an *indirect* call using ESP (e.g., CALL [ESP]). The saved version of ESP should be popped off the stack after the call returns.

Status: For the steppings affected see the *Summary of Changes* at the beginning of this section.

C15. Built-in Self Test Always Gives Nonzero Result

Problem: The Built-in Self Test (BIST) of the Celeron processor does not give a zero result to indicate a passing test. Regardless of pass or fail status, bit 6 of the BIST result in the EAX register after running BIST is set.

Implication: Software which relies on a zero result to indicate a passing BIST will indicate BIST failure.

Workaround: Mask bit 6 of the BIST result register when analyzing BIST results.

Status: For the steppings affected see the *Summary of Changes* at the beginning of this section.

C16. THERMTRIP# May Not Be Asserted as Specified

Problem: THERMTRIP# is a signal on the Celeron processor which is asserted when the core reaches a critical temperature during operation as detailed in the processor specification. The Celeron processor may not assert THERMTRIP# until a much higher temperature than the one specified is reached.

Implication: The THERMTRIP# feature is not functional on the Celeron processor. Note that this erratum can only occur when the processor is running with a T_{PLATE} temperature over the maximum specification of 75° C.

Workaround: Avoid operation of the Celeron processor outside of the thermal specifications defined by the processor specifications.

Status: For the steppings affected see the *Summary of Changes* at the beginning of this section.

C17. Cache State Corruption in the Presence of Page A/D-bit Setting and Snoop Traffic

Problem: If an operating system uses the Page Access and/or Dirty bit feature implemented in the Intel architecture and there is a significant amount of snoop traffic on the bus, while the processor is setting the Access and/or Dirty bit the processor may inappropriately change a single L1 cache line to the modified state.

Implication: The occurrence of this erratum may result in cache incoherency, which may cause parity errors, data corruption (with no parity error), unexpected application or operating system termination, or system hangs.

Workaround: It is possible for BIOS code to contain a workaround for this erratum.

Status: For the steppings affected see the *Summary of Changes* at the beginning of this section.

C18. Snoop Cycle Generates Spurious Machine Check Exception

Problem: The processor may incorrectly generate a Machine Check Exception (MCE) when it processes a snoop access that does not hit the L1 data cache. Due to an internal logic error, this type of snoop cycle may still check data parity on undriven data lines. The processor generates a spurious machine check exception as a result of this unnecessary parity check.

Implication: A spurious machine check exception may result in an unexpected system halt if Machine Check Exception reporting is enabled in the operating system.

Workaround: It is possible for BIOS code to contain a workaround for this erratum. This workaround would fix the erratum, however, the reporting of the data parity error will continue.

Status: For the steppings affected see the *Summary of Changes* at the beginning of this section.

C19. MOVD/MOVQ Instruction Writes to Memory Prematurely

Problem: When an instruction encounters a fault, the faulting instruction should not modify any CPU or system state. However, when the MMX™ technology store instructions MOVD and MOVQ encounter any of the following events, it is possible for the store to be committed to memory even though it should be canceled:

1. If CR0.EM = 1 (Emulation bit), then the store could happen prior to the triggered invalid opcode exception.
2. If the floating-point Top-of-Stack (FP TOS) is not zero, then the store could happen prior to executing the processor assist routine that sets the FP TOS to zero.
3. If there is an unmasked floating-point exception pending, then the store could happen prior to the triggered unmasked floating-point exception.
4. If CR0.TS = 1 (Task Switched bit), then the store could happen prior to the triggered Device Not Available (DNA) exception.

If the MOVD/MOVQ instruction is restarted after handling any of the above events, then the store will be performed again, overwriting with the expected data. The instruction will not be restarted after event 1. The instruction will definitely be restarted after events 2 and 4. The instruction may or may not be restarted after event 3, depending on the specific exception handler.

Implication: This erratum causes unpredictable behavior in an application if MOVD/MOVQ instructions are used to manipulate semaphores for multiprocessor synchronization, or if these MMX instructions are used to write to uncacheable memory or memory mapped I/O that has side effects, e.g., graphics devices. This erratum is completely transparent to all applications that do not have these characteristics. When each of the above conditions are analyzed:

1. Setting the CR0.EM bit forces all floating-point/MMX instructions to be handled by software emulation. The MOVD/MOVQ instruction, which is an MMX instruction, would be considered an invalid instruction. Operating systems typically terminates the application after getting the expected invalid opcode fault.
2. The FP TOS not equal to 0 case only occurs when the MOVD/MOVQ store is the first MMX instruction in an MMX technology routine and the previous floating-point routine did not clean up the floating-point states properly when it exited. Floating-point routines commonly leave TOS to 0 prior to exiting. For a store to be executed as the first MMX instruction in an MMX technology routine following a floating-point routine, the software would be implementing instruction level intermixing of floating-point and MMX instructions. Intel does not recommend this practice.

3. The unmasked floating-point exception case only occurs if the store is the first MMX technology instruction in an MMX technology routine and the previous floating-point routine exited with an unmasked floating-point exception pending. Again, for a store to be executed as the first MMX instruction in an MMX technology routine following a floating-point routine, the software would be implementing instruction level intermixing of floating-point and MMX instructions. Intel does not recommend this practice.

Device Not Available (DNA) exceptions occur naturally when a task switch is made between two tasks that use either floating-point instructions and/or MMX instructions. For this erratum, in the event of the DNA exception, data from the prior task may be temporarily stored to the present task's program state.

Workaround: Do not use MMX instructions to manipulate semaphores for multiprocessor synchronization. Do not use MOVD/MOVQ instructions to write directly to I/O devices if doing so triggers user visible side effects. An OS can prevent old data from being stored to a new task's program state by cleansing the FPU explicitly after every task switch. Follow Intel's recommended programming paradigms in the *Intel Architecture Developer's Optimization Manual* for writing MMX technology programs. Specifically, do not mix floating-point and MMX instructions. When transitioning to new a MMX technology routine, begin with an instruction that does not depend on the prior state of either the MMX technology registers or the floating-point registers, such as a load or PXOR mm0, mm0. Be sure that the FP TOS is clear before using MMX instructions.

Status: For the steppings affected see the *Summary of Changes* at the beginning of this section.

C20. Memory Type Undefined for Nonmemory Operations

Problem: The Memory Type field for nonmemory transactions such as I/O and Special Cycles are undefined. Although the Memory Type attribute for nonmemory operations logically should (and usually does) manifest itself as UC, this feature is not designed into the implementation and is therefore inconsistent.

Implication: Bus agents may decode a non-UC memory type for nonmemory bus transactions.

Workaround: Bus agents must consider transaction type to determine the validity of the Memory Type field for a transaction.

Status: For the steppings affected see the *Summary of Changes* at the beginning of this section.

C21. Bus Protocol Conflict With Optimized Chipsets

Problem: A "dead" turnaround cycle with no agent driving the address, address parity, request command, or request parity signals must occur between the processor driving these signals and the chipset driving them after asserting BPRI#. The Celeron processor does not follow this protocol. Thus, if a system uses a chipset or third party agent which optimizes its arbitration latency (reducing it to 2 clocks when it observes an active (low) ADS# signal and an inactive (high) LOCK# signal on the same clock that BPRI# is asserted (driven low)), the Celeron processor may cause bus contention during an unlocked bus exchange.

Implication: This violation of the bus exchange protocol when using a reduced arbitration latency may cause a system-level setup timing violation on the address, address parity, request command, or request parity signals on the system bus. This may result in a system hang or assertion of the AERR# signal, causing an attempted corrective action or shutdown of the system, as the system hardware and software dictate. The possibility of failure due to the contention caused by this erratum may be increased due to the processor's internal active pull-up of these signals on the clock after the signals are no longer being driven by the processor.



Workaround: If the chipset and third party agents used with the Celeron processor do not optimize their arbitration latency as described above, no action is required. For the 66 MHz Celeron processor, no action is required.

Status: For the steppings affected see the *Summary of Changes* at the beginning of this section.

C22. FP Data Operand Pointer May Not Be Zero After Power On or Reset

Problem: The FP Data Operand Pointer, as specified, should be reset to zero upon power on or Reset by the processor. Due to this erratum, the FP Data Operand Pointer may be nonzero after power on or Reset.

Implication: Software which uses the FP Data Operand Pointer and count on its value being zero after power on or Reset without first executing an FINIT/FNINIT instruction will use an incorrect value, resulting in incorrect behavior of the software.

Workaround: Software should follow the recommendation in Section 8.2 of the *Intel Architecture Software Developer's Manual, Volume 3: System Programming Guide* (Order Number 243192). This recommendation states that if the FPU will be used, software-initialization code should execute an FINIT/FNINIT instruction following a hardware reset. This will correctly clear the FP Data Operand Pointer to zero.

Status: For the steppings affected see the *Summary of Changes* at the beginning of this section.

C23. *MOVD Following Zeroing Instruction Can Cause Incorrect Result*

Problem: An incorrect result may be calculated after the following circumstances occur:

1. A register has been zeroed with either a SUB reg, reg instruction or an XOR reg, reg instruction,
2. A value is moved with sign extension into the same register's lower 16 bits; or a signed integer multiply is performed to the same register's lower 16 bits,
3. This register is then copied to an MMX™ technology register using the MOVD instruction prior to any other operations on the sign-extended value.

Specifically, the sign may be incorrectly extended into bits 16-31 of the MMX technology register. Only the MMX technology register is affected by this erratum.

The erratum only occurs when the 3 following steps occur in the order shown. The erratum may occur with up to 40 intervening instructions that do not modify the sign-extended value between steps 2 and 3.

1. XOR EAX, EAX
or SUB EAX, EAX
2. MOVXSX AX, BL
or MOVXSX AX, byte ptr <memory address> or MOVXSX AX, BX
or MOVXSX AX, word ptr <memory address> or IMUL BL (AX implicit, opcode F6 /5)
or IMUL byte ptr <memory address> (AX implicit, opcode F6 /5) or IMUL AX, BX (opcode 0F AF /r)
or IMUL AX, word ptr <memory address> (opcode 0F AF /r) or IMUL AX, BX, 16 (opcode 6B /r ib)
or IMUL AX, word ptr <memory address>, 16 (opcode 6B /r ib) or IMUL AX, 8 (opcode 6B /r ib)
or IMUL AX, BX, 1024 (opcode 69 /r iw)
or IMUL AX, word ptr <memory address>, 1024 (opcode 69 /r iw) or IMUL AX, 1024 (opcode 69 /r iw)
or CBW
3. MOVD MM0, EAX

Note that the values for immediate byte/words are merely representative (i.e., 8, 16, 1024) and that any value in the range for the size may be affected. Also, note that this erratum may occur with "EAX" replaced with any 32-bit general purpose register, and "AX" with the corresponding 16-bit version of that replacement. "BL" or "BX" can be replaced with any 8-bit or 16-bit general purpose register. The CBW and IMUL (opcode F6 /5) instructions are specific to the EAX register only.

In the example, EAX is forced to contain 0 by the XOR or SUB instructions. Since the four types of the MOVXSX or IMUL instructions and the CBW instruction modify only bits 15:8 of EAX by sign extending the lower 8 bits of EAX, bits 31:16 of EAX should always contain 0. This implies that when MOVD copies EAX to MM0, bits 31:16 of MM0 should also be 0. Under certain scenarios, bits 31:16 of MM0 are not 0, but are replicas of bit 15 (the 16th bit) of AX. This is noticeable when the value in AX after the MOVXSX, IMUL or CBW instruction is negative, i.e., bit 15 of AX is a 1.

When AX is positive (bit 15 of AX is a 0), MOVD will always produce the correct answer. If AX is negative (bit 15 of AX is a 1), MOVD may produce the right answer or the wrong answer depending on the point in time when the MOVD instruction is executed in relation to the MOVXSX, IMUL or CBW instruction.

Implication: The effect of incorrect execution will vary from unnoticeable, due to the code sequence discarding the incorrect bits, to an application failure. If the MMX technology-enabled application in which MOVD is used to manipulate pixels, it is possible for one or more pixels to exhibit the wrong color or position momentarily. It is also possible for a computational application that uses the MOVD instruction in the manner described above to produce incorrect data. Note that this data may cause an unexpected page fault or general protection fault.

Workaround: There are two possible workarounds for this erratum:

1. Rather than using the MOVSX-MOVD or CBW-MOVD pairing to handle one variable at a time, use the sign extension capabilities (PSRAW, etc.) within MMX technology for operating on multiple variables. This would result in higher performance as well.
2. Insert another operation that modifies or copies the sign-extended value between the MOVSX/IMUL/CBW instruction and the MOVD instruction as in the example below:

```
XOR EAX, EAX (or SUB EAX, EAX)
MOVSX AX, BL (or other MOVSB, other IMUL or CBW instruction)
*MOV EAX, EAX
MOVD MM0, EAX
```

*Note: MOV EAX, EAX is used here as it is fairly generic. Again, EAX can be any 32-bit register.

Status: For the steppings affected see the *Summary of Changes* at the beginning of this section.

C24. Premature Execution of a Load Operation Prior to Exception Handler Invocation

Problem: This erratum can occur with any of the following situations:

1. If an instruction that performs a memory load causes a code segment limit violation
2. If a waiting floating-point instruction or MMX™ instruction that performs a memory load has a floating-point exception pending
3. If an MMX instruction that performs a memory load and has either CR0.EM = 1 (Emulation bit set), or a floating-point Top-of-Stack (FP TOS) not equal to 0, or a DNA exception pending

If any of the above circumstances occur, it is possible that the load portion of the instruction will have executed before the exception handler is entered.

Implication: In normal code execution where the target of the load operation is to write back memory there is no impact from the load being prematurely executed, nor from the restart and subsequent re-execution of that instruction by the exception handler. If the target of the load is to uncached memory that has a system side effect, restarting the instruction may cause unexpected system behavior due to the repetition of the side effect.

Workaround: Code which performs loads from memory that has side-effects can effectively workaround this behavior by using simple integer-based load instructions when accessing side-effect memory and by ensuring that all code is written such that a code segment limit violation cannot occur as a part of reading from side-effect memory.

Status: For the steppings affected see the *Summary of Changes* at the beginning of this section.

C25. Read Portion of RMW Instruction May Execute Twice

Problem: When the Celeron processor executes a read-modify-write (RMW) arithmetic instruction, with memory as the destination, it is possible for a page fault to occur during the execution of the store on the memory operand after the read operation has completed but before the write operation completes.

If the memory targeted for the instruction is UC (uncached), memory will observe the occurrence of the initial load before the page fault handler and again if the instruction is restarted.

Implication: This erratum has no effect if the memory targeted for the RMW instruction has no side-effects. If, however, the load targets a memory region that has side-effects, multiple occurrences of the initial load may lead to unpredictable system behavior.

Workaround: Hardware and software developers who write device drivers for custom hardware that may have a side-effect style of design should use simple loads and simple stores to transfer data to and from the device. Then the memory location will simply be read twice with no additional implications.

Status: For the steppings affected see the *Summary of Changes* at the beginning of this section.

C26. Test Pin Must Be High During Power Up

Problem: The Celeron processor uses the PWRGOOD signal to ensure that no voltage sequencing issues arise; no pin assertions should cause the processor to change its behavior until this signal is asserted, when all power supplies and clocks to the processor are valid and stable. However, if the TESTHI signal is at a low voltage level when the core power supply comes up, it will cause the processor to enter an invalid test state.

Implication: If this erratum occurs, the system may boot normally however, L2 cache may not be initialized.

Workaround: Ensure that the 2.5 V ($V_{CC2.5}$) power supply ramps at or before the 2.0 V (V_{CCCORE}) power plane. If 2.5 V ramps after core, pull up TESTHI to 2.5 V ($V_{CC2.5}$) with a 100K Ohm resistor. The internal pull-up will keep the signal from being asserted during power up. For new motherboard designs, it is recommended that TESTHI be pulled up to 2.0 V (V_{CCCORE}) using a 1K-10K Ohm resistor.

Status: For the steppings affected see the *Summary of Changes* at the beginning of this section.

C27. Intervening Writeback May Occur During Locked Transaction

Problem: During a transaction which has the LOCK# signal asserted (i.e., a locked transaction), there is a potential for an explicit writeback caused by a previous transaction to complete while the bus is locked. The explicit writeback will only be issued by the processor which has locked the bus, and the lock signal will not be deasserted until the locked transaction completes, but the atomicity of a lock may be compromised by this erratum. Note that the explicit writeback is an expected cycle, and no memory ordering violations will occur. This erratum is, however, a violation of the bus lock protocol.

Implication: A chipset or third-party agent (TPA) which tracks bus transactions in such a way that locked transactions may only consist of a read-write or read-read-write-write locked sequence, with no transactions intervening, may lose synchronization of state due to the intervening explicit writeback. Systems using chipsets or TPAs which can accept the intervening transaction will not be affected.

Workaround: The bus tracking logic of all devices on the system bus should allow for the occurrence of an intervening transaction during a locked transaction.

Status: For the steppings affected see the *Summary of Changes* at the beginning of this section.

C28. MC2_STATUS MSR Has Model-Specific Error Code and Machine Check Architecture Error Code Reversed

Problem: The *Intel Architecture Software Developer's Manual, Volume 3: System Programming Guide*, documents that for the MC_i_STATUS MSR, bits 15:0 contain the MCA (machine-check architecture) error code fields and bits 31:16 contain the model-specific error code field. However, for the MC2_STATUS MSR, these bits have been reversed. For the MC2_STATUS MSR, bits 15:0 contain the model-specific error code field and bits 31:16 contain the MCA error code field.

Implication: A machine check error may be decoded incorrectly if this erratum on the MC2_STATUS MSR is not taken into account.

Workaround: When decoding the MC2_STATUS MSR, reverse the two error fields.

Status: For the steppings affected see the *Summary of Changes* at the beginning of this section.

C29. MOV With Debug Register Causes Debug Exception

Problem: When in V86 mode, if a MOV instruction is executed on debug registers, a general-protection exception (#GP) should be generated, as documented in the *Intel Architecture Software Developer's Manual, Volume 3: System Programming Guide*, Section 15.2. However, in the case when the general detect enable flag (GD) bit is set, the observed behavior is that a debug exception (#DB) is generated instead.

Implication: With debug-register protection enabled (i.e., the GD bit set), when attempting to execute a MOV on debug registers in V86 mode, a debug exception will be generated instead of the expected general-protection fault.

Workaround: In general, operating systems do not set the GD bit when they are in V86 mode. The GD bit is generally set and used by debuggers. The debug exception handler should check that the exception did not occur in V86 mode before continuing. If the exception did occur in V86 mode, the exception may be directed to the general-protection exception handler.

Status: For the steppings affected see the *Summary of Changes* at the beginning of this section.

C30. Upper Four PAT Entries Not Usable With Mode B or Mode C Paging

Problem: The Page Attribute Table (PAT) contains eight entries, which must all be initialized and considered when setting up memory types for the Celeron processor. However, in Mode B or Mode C paging, the upper four entries do not function correctly for 4-Kbyte pages. Specifically, bit seven of page table entries that translate addresses to 4-Kbyte pages should be used as the upper bit of a three-bit index to determine the PAT entry that specifies the memory type for the page. When Mode B (CR4.PSE = 1) and/or Mode C (CR4.PAE) are enabled, the processor forces this bit to zero when determining the memory type regardless of the value in the page table entry. The upper four entries of the PAT function correctly for 2-Mbyte and 4-Mbyte large pages (specified by bit 12 of the page directory entry for those translations).

Implication: Only the lower four PAT entries are useful for 4-Kbyte translations when Mode B or C paging is used. In Mode A paging (4-Kbyte pages only), all eight entries may be used. All eight entries may be used for large pages in Mode B or C paging.

Workaround: None identified

Status: For the steppings affected see the *Summary of Changes* at the beginning of this section.

C31. Incorrect Memory Type May Be Used When MTRRs Are Disabled

Problem: If the Memory Type Range Registers (MTRRs) are disabled without setting the CR0.CD bit to disable caching, and the Page Attribute Table (PAT) entries are left in their default setting, which includes UC- memory type (PCD = 1, PWT = 0; see the *Intel Architecture Software Developer's Manual, Volume 3: System Programming Guide*, for details), data for entries set to UC- will be cached as if the memory type were writeback (WB). Also, if the page tables are set to a memory type other than UC-, then the effective memory type used will be that specified by the page tables and PAT. Any regions of memory normally forced to UC by the MTRRs (such as the VGA video region) may now be incorrectly cached and speculatively accessed.

Even if the CR0.CD bit is correctly set when the MTRRs are disabled and the PAT is left in its default state, then retries and out of order retirement of UC accesses may occur, contrary to the strong ordering expected for these transactions.

Implication: The occurrence of this erratum may result in the use of incorrect data and unpredictable processor behavior when running with the MTRRs disabled. Interaction between the mouse, cursor, and VGA video display leading to video corruption may occur as a symptom of this erratum as well.

Workaround: Ensure that when the MTRRs are disabled, the CR0.CD bit is set to disable caching. This recommendation is described in *Intel Architecture Software Developer's Manual, Volume 3: System Programming Guide*. If it is necessary to disable the MTRRs, first clear the PAT register before setting the CR0.CD bit, flushing the caches, and disabling the MTRRs to ensure that UC memory type is always returned and strong ordering is maintained.

Status: For the steppings affected see the *Summary of Changes* at the beginning of this section.

C32. *Misprediction in Program Flow May Cause Unexpected Instruction Execution*

Problem: To optimize performance through dynamic execution technology, the P6 architecture has the ability to predict program flow. In the event of a misprediction, the processor will normally clear the incorrect prediction, adjust the EIP to the correct location, and flush out any instructions it may have fetched from the misprediction. In circumstances where a branch misprediction occurs, the correct target of the branch has already been opportunistically fetched into the streaming buffers, and the L2 cycle caused by the evicted cache line is retried by the L2 cache, the processor may fail to flush out the retirement unit before the speculative program flow is committed to a permanent state.

Implication: The results of this erratum may range from no effect to unpredictable application or OS failure. Manifestations of this failure may result in:

- Unexpected values in EIP
- Faults or traps (e.g., page faults) on instructions that do not normally cause faults
- Faults in the middle of instructions
- Unexplained values in registers/memory at the correct EIP

Workaround: It is possible for BIOS code to contain a workaround for this erratum.

Status: For the steppings affected see the *Summary of Changes* at the beginning of this section.

C33. *Data Breakpoint Exception in a Displacement Relative Near Call May Corrupt EIP*

Problem: If a misaligned data breakpoint is programmed to the same cache line as the memory location where the stack push of a near call is performed and any data breakpoints are enabled, the processor will update the stack and ESP appropriately, but may skip the code at the destination of the call. Hence, program execution will continue with the next instruction immediately following the call, instead of the target of the call.

Implication: The failure mechanism for this erratum is that the call would not be taken; therefore, instructions in the called subroutine would not be executed. As a result, any code relying on the execution of the subroutine will behave unpredictably.

Workaround: Whether enabled or not, do not program a misaligned data breakpoint to the same cache line on the stack where the push for the near call is performed.

Status: For the stepping affected see the *Summary of Changes* at the beginning of this section.

C34. *System Bus ECC Not Functional With 2:1 Ratio*

Problem: If a processor is underclocked at a core frequency to system bus frequency ratio of 2:1 and system bus ECC is enabled, the system bus ECC detection and correction will negatively affect internal timing dependencies.

Implication: If system bus ECC is enabled, and the processor is underclocked at a 2:1 ratio, the system may behave unpredictably due to these timing dependencies.

Workaround: All bus agents that support system bus ECC must disable it when a 2:1 ratio is used.

Status: For the steppings affected see the *Summary of Changes* at the beginning of this section.

C35. *Fault on REP CMPS/SCAS Operation May Cause Incorrect EIP*

Problem: If either a General Protection Fault, Alignment Check Fault or Machine Check Exception occur during the first iteration of a REP CMPS or a REP SCAS instruction, an incorrect EIP may be pushed onto the stack of the event handler if all the following conditions are true:

- The event occurs on the initial load performed by the instruction(s)
- The condition of the zero flag before the repeat instruction happens to be opposite of the repeat condition (i.e., REP/REPE/REPZ CMPS/SCAS with ZF = 0 or RENE/REPNZ CMPS/SCAS with ZF = 1)
- The faulting micro-op and a particular micro-op of the REP instruction are retired in the retirement unit in a specific sequence

The EIP will point to the instruction following the REP CMPS/SCAS instead of pointing to the faulting instruction.

Implication: The result of the incorrect EIP may range from no effect to unexpected application/OS behavior.

Workaround: None identified

Status: For the steppings affected see the *Summary of Changes* at the beginning of this section.

C36. *RDMSR or WRMSR To Invalid MSR Address May Not Cause GP Fault*

Problem: The RDMSR and WRMSR instructions allow reading or writing of MSRs (Model Specific Registers) based on the index number placed in ECX. The processor should reject access to any reserved or unimplemented MSRs by generating #GP(0). However, there are some invalid MSR addresses for which the processor will not generate #GP(0).

Implication: For RDMSR, undefined values will be read into EDX:EAX. For WRMSR, undefined processor behavior may result.

Workaround: Do not use invalid MSR addresses with RDMSR or WRMSR.

Status: For the steppings affected see the *Summary of Changes* at the beginning of this section.

C37. SYSENTER/SYSEXIT Instructions Can Implicitly Load “Null Segment Selector” to SS and CS Registers

Problem: According to the processor specification, attempting to load a null segment selector into the CS and SS segment registers should generate a General Protection Fault (#GP). Although loading a null segment selector to the other segment registers is allowed, the processor will generate an exception when the segment register holding a null selector is used to access memory.

However, the SYSENTER instruction can implicitly load a null value to the SS segment selector. This can occur if the value in SYSENTER_CS_MSR is between FFF8h and FFFBh when the SYSENTER instruction is executed. This behavior is part of the SYSENTER/SYSEXIT instruction definition; the content of the SYSTEM_CS_MSR is always incremented by 8 before it is loaded into the SS. This operation will set the null bit in the segment selector if a null result is generated, but it does not generate a #GP on the SYSENTER instruction itself. An exception will be generated as expected when the SS register is used to access memory, however.

The SYSEXIT instruction will also exhibit this behavior for both CS and SS when executed with the value in SYSENTER_CS_MSR between FFF0h and FFF3h, or between FFE8h and FFEbH.

Implication: These instructions are intended for operating system use. If this erratum occurs (and the OS does not ensure that the processor never has a null segment selector in the SS or CS segment registers), the processor's behavior may become unpredictable, possibly resulting in system failure.

Workaround: Do not initialize the SYSTEM_CS_MSR with the values between FFF8h and FFFBh, FFF0h and FFF3h, or FFE8h and FFEbH before executing SYSENTER or SYSEXIT.

Status: For the steppings affected see the *Summary of Changes* at the beginning of this section.

C38. PRELOAD Followed by EXTEST Does Not Load Boundary Scan Data

Problem: According to the IEEE 1149.1 Standard, the EXTEST instruction would use data “typically loaded onto the latched parallel outputs of boundary-scan shift-register stages using the SAMPLE/PRELOAD instruction prior to the selection of the EXTEST instruction.” As a result of this erratum, this method cannot be used to load the data onto the outputs.

Implication: Using the PRELOAD instruction prior to the EXTEST instruction will not produce expected data after the completion of EXTEST.

Workaround: None identified

Status: For the steppings affected see the *Summary of Changes* at the beginning of this section.

C39. Far Jump to New TSS With D-bit Cleared May Cause System Hang

Problem: A task switch may be performed by executing a far jump through a task gate or to a new Task State Segment (TSS) directly. Normally, when such a jump to a new TSS occurs, the D-bit (which indicates that the page referenced by a Page Table Entry (PTE) has been modified) for the PTE which maps the location of the previous TSS will already be set and the processor will operate as expected. However, if the D-bit is clear at the time of the jump to the new TSS, the processor will hang.

Implication: If an OS is used which can clear the D-bit for system pages, and which jumps to a new TSS on a task switch, then a condition may occur which results in a system hang. Intel has not identified any commercial software which may encounter this condition; this erratum was discovered in a focused testing environment.

Workaround: Ensure that OS code does not clear the D-bit for system pages (including any pages that contain a task gate or TSS). Use task gates rather than jumping to a new TSS when performing a task switch.

Status: For the steppings affected see the *Summary of Changes* at the beginning of this section.

C40. Incorrect Chunk Ordering May Prevent Execution of the Machine Check Exception Handler After BINIT#

Problem: If a catastrophic bus error is detected which results in a BINIT# assertion, and the BINIT# assertion is propagated to the processor's L2 cache at the same time that data is being sent to the processor, then the data may become corrupted in the processor's L1 cache.

Implication: Since BINIT# assertion is due to a catastrophic event on the bus, the corrupted data will not be used. However, it may prevent the processor from executing the Machine Check Exception (MCE) handler, causing the system to hang.

Workaround: None identified

Status: For the steppings affected see the *Summary of Changes* at the beginning of this section.



C41. UC Write May Be Reordered Around a Cacheable Write

Problem: After a write occurs to a UC (uncacheable) region of memory, there exists a small window of opportunity where a subsequent write transaction targeted for a UC memory region may be reordered in front of a write targeted to a region of cacheable memory. This erratum can only occur during the following sequence of bus transactions:

1. A write to memory mapped as UC occurs
2. A write to memory mapped as cacheable (WB or WT) which is present in Shared or Invalid state in the L2 cache occurs
3. During the bus snoop of the cacheable line, another store to UC memory occurs

Implication: If this erratum occurs, the second UC write will be observed on the bus prior to the Bus Invalidate Line (BIL) or Bus Read Invalidate Line (BRIL) transaction for the cacheable write. This presents a small window of opportunity for a fast bus-mastering I/O device which triggers an action based on the second UC write to arbitrate and gain ownership of the bus prior to the completion of the cacheable write, possibly retrieving stale data.

Workaround: It is possible for BIOS code to contain a workaround for this erratum.

Status: For the steppings affected see the *Summary of Changes* at the beginning of this section.

C42. Resume Flag May Not Be Cleared After Debug Exception

Problem: The Resume Flag (RF) is normally cleared by the processor after executing an instruction which causes a debug exception (#DB). In the process of determining whether the RF needs to be cleared after executing the instruction, the processor uses an internal register containing stale data. The stale data may unpredictably prevent the processor from clearing the RF.

Implication: If this erratum occurs, further debug exceptions will be disabled.

Workaround: None identified

Status: For the steppings affected see the *Summary of Changes* at the beginning of this section.

C43. Internal Cache Protocol Violation May Cause System Hang

Problem: A Celeron processor-based system may hang due to an internal cache protocol violation. During multiple transactions targeted at the same cacheline, there exists a small window of time such that the processor's internal timings align to create a livelock situation. The scenario, which results in the erratum, is summarized below:

Scenario:

1. A snoopable transaction is issued to address A. This snoopable transaction can be issued by the processor or the chipset.
2. The snoopable transaction hits a modified line in the processor's L1 data cache.
3. The processor issues two code fetches from the L2 cache before the snoopable transaction reaches the top of the In-Order Queue and before the snoopable transaction's modified L1 cache line containing address A is brought out on the system bus.

At the same time, a locked access to the L1 cache occurs.

Implication: A Celeron processor may cause a system to hang if the above listed sequence of events occur. The probability of encountering this erratum increases with I/O queue depth greater than four.

Workaround: It is possible for the BIOS code to contain a workaround for this erratum.

Status: For the steppings affected see the *Summary of Changes* at the beginning of this section.

C44. GP# Fault on WRMSR to ROB_CR_BKUPTMPDR6

Problem: Writing a '1' to unimplemented bit(s) in the ROB_CR_BKUPTMPDR6 MSR (offset 1E0h) will result in a general protection fault (GP#).

Implication: The normal process used to write an MSR is to read the MSR using RDMSR, modify the bit(s) of interest, and then to write the MSR using WRMSR. Because of this erratum, this process may result in a GP# fault when used to modify the ROB_CR_BKUPTMPDR6 MSR.

Workaround: When writing to ROB_CR_BKUPTMPDR6 all unimplemented bits must be '0.' Implemented bits may be set as '0' or '1' as desired.

Status: For the steppings affected see the *Summary of Changes* at the beginning of this section.

C45. Machine Check Exception May Occur Due to Improper Line Eviction in the IFU

Problem: The Celeron processor is designed to signal an unrecoverable Machine Check Exception (MCE) as a consistency checking mechanism. Under a complex set of circumstances involving multiple speculative branches and memory accesses there exists a one cycle long window in which the processor may signal a MCE in the Instruction Fetch Unit (IFU) because instructions previously decoded have been evicted from the IFU. The one cycle long window is opened when an opportunistic fetch receives a partial hit on a previously executed but not as yet completed store resident in the store buffer. The resulting partial hit erroneously causes the eviction of a line from the IFU at a time when the processor is expecting the line to still be present. If the MCE for this particular IFU event is disabled, execution will continue normally.

Implication: Since the probability of this erratum occurring increases with the number of processors, the risk is lower on Celeron processor-based systems as they do not have multi-processor support. If this erratum does occur, a machine check exception will result. Note systems that implement an operating system that does not enable the Machine Check Architecture will be completely unaffected by this erratum (e.g., Windows* 95 and Windows 98).

Workaround: It is possible for BIOS code to contain a workaround for this erratum.

Status: For the steppings affected see the *Summary of Changes* at the beginning of this section.

C46. Lower Bits of SMRAM SMBASE Register Cannot Be Written With an ITP

Problem: The System Management Base (SMBASE) register (7EF8H) stores the starting address of the System Management RAM (SMRAM). This register is used by the processor when it is in System Management Mode (SMM), and its contents serve as the memory base for code execution and data storage. The 32-bit SMBASE register can normally be programmed to any value. When programmed with an In-Target Probe (ITP), however, any attempt to set the lower 11 bits of SMBASE to anything other than zeros via the WRMSR instruction will cause the attempted write to fail.

Implication: When set via an ITP, any attempt to relocate SMRAM space must be made with 2-Kbyte alignment.

Workaround: None identified

Status: For the steppings affected see the *Summary of Changes* at the beginning of this section.

C47. Task Switch May Cause Wrong PTE and PDE Access Bit to be Set

Problem: If an operating system executes a task switch via a Task State Segment (TSS), and the TSS is wholly or partially located within a clean page (A and D bits clear) and the GDT entry for the new TSS is either misaligned across a cache line boundary or is in a clean page, the accessed and dirty bits for an incorrect page table/directory entry may be set.

Implication: An operating system that uses hardware task switching (or hardware task management) may encounter this erratum. The effect of the erratum depends on the alignment of the TSS and ranges from no anomalous behavior to unexpected errors.

Workaround: The operating system could align all TSSs to be within page boundaries and set the A and D bits for those pages to avoid this erratum. The operating system may alternately use software task management.

Status: For the steppings affected see the *Summary of Changes* at the beginning of this section.

C48. Cross Modifying Code Operations on a Jump Instruction May Cause a General Protection Fault

Problem: The act of one processor writing data into the currently executing code segment of a second processor with the intent of having the second processor execute that data as code is called Cross-Modifying Code (XMC). Software using XMC to modify the offset of an execution transfer instruction (i.e., Jump, Call etc.), without a synchronizing instruction may cause a General Protection Fault (GPF) when the offset splits a cache line boundary.

Implication: Any application creating a (GPF) would be terminated by the operating system.

Workaround: Programmers should use the cross modifying code synchronization algorithm as detailed in Volume 3 of the *Intel Architecture Software Developer's Manual*, section 7.1.3, in order to avoid this erratum.

Status: For the steppings affected see the *Summary of Changes* at the beginning of this section.

C49. Deadlock May Occur Due To Illegal-Instruction/Page-Miss Combination

Problem: Intel's 32-bit Instruction Set Architecture (ISA) utilizes most of the available op-code space; however some byte combinations remain undefined and are considered illegal instructions. Intel processors detect the attempted execution of illegal instructions and signal an exception. This exception is handled by the operating system and/or application software.

Under a complex set of internal and external conditions involving illegal instructions, a deadlock may occur within the processor. The necessary conditions for the deadlock involve:

1. The illegal instruction is executed.
2. Two page table walks occur within a narrow timing window coincident with the illegal instruction.

Implication: The illegal instructions involved in this erratum are unusual and invalid byte combinations that are not useful to application software or operating systems. These combinations are not normally generated in the course of software programming, nor are such sequences known by Intel to be generated in commercially available software and tools. Development tools (compilers, assemblers) do not generate this type of code sequence, and will normally flag such a sequence as an error. If this erratum occurs, the processor deadlock condition will occur and result in a system hang. Code execution cannot continue without a system RESET.

Workaround: None identified

Status: For the steppings affected see the *Summary of Changes* at the beginning of this section.

C50. FLUSH# Assertion Following STPCLK# May Prevent CPU Clocks From Stopping

Problem: If FLUSH# is asserted after STPCLK# is asserted, the cache flush operation will not occur until after STPCLK# is de-asserted. Furthermore, the pending flush will prevent the processor from entering the Sleep state, since the flush operation must complete prior to the processor entering the Sleep state.

Implication: Following SLP# assertion, processor power dissipation may be higher than expected. Furthermore, if the source to the processor's input bus clock (BCLK) is removed, normally resulting in a transition to the Deep Sleep state, the processor may shutdown improperly. The ensuing attempt to wake up the processor will result in unpredictable behavior and may cause the system to hang.

Workaround: For systems that use the FLUSH# input signal and Deep Sleep state of the processor, ensure that FLUSH# is not asserted while STPCLK# is asserted.

Status: For the steppings affected see the *Summary of Changes* at the beginning of this section.

C51. Floating-Point Exception Condition May be Deferred

Problem: A floating-point instruction that causes a pending floating-point exception (ES=1) is normally signaled by the processor on the next waiting FP/MMX™ technology instruction. In the following set of circumstances, the exception may be delayed or the FSW register may contain a wrong value:

1. The excepting floating-point instruction is followed by an instruction that accesses memory across a page (4 Kbyte) boundary or its access results in the update of a page table dirty/access bit.
2. The memory accessing instruction is immediately followed by a waiting floating-point or MMX technology instruction.
3. The waiting floating-point or MMX technology instruction retires during a one-cycle window that coincides with a sequence of internal events related to instruction cache line eviction.

Implication: The floating-point exception will not be signaled until the next waiting floating-point/MMX technology instruction. Alternatively it may be signaled with the wrong TOS and condition code values. This erratum has not been observed in any commercial software applications.

Workaround: None identified

Status: For the stepping affected see *the Summary of Changes* at the beginning of this section.

C52. Cache Line Reads May Result in Eviction of Invalid Data

Problem: A small window of time exists in which internal timing conditions in the processor cache logic may result in the eviction of an L2 cache line marked in the invalid state.

Implication: There are three possible implications of this erratum:

1. The processor may provide incorrect L2 cache line data by evicting an invalid line.
2. A BNR# (Block Next Request) stall may occur on the system bus.
3. Should a snoop request occur to the same cache line in a small window of time, the processor may incorrectly assert HITM#. It is then possible for an infinite snoop stall to occur should another processor respond (correctly) to the snoop request with HIT#. In order for this infinite snoop stall to occur, at least three agents must be present, and the probability of occurrence increases with the number of processors.

Should 2 or 3 occur, the processor will eventually assert BINIT# (if enabled) with an MCA error code indicating a ROB time-out. At this point, the system requires a hard reset.

Workaround: It is possible for BIOS code to contain a workaround for this erratum.

Status: For the steppings affected, see the *Summary of Changes* at the beginning of this section.

C53. FLUSH# Servicing Delayed While Waiting for STARTUP_IPI in 2-way MP Systems

Problem: In a 2-way MP system, if an application processor is waiting for a startup inter-processor interrupt (STARTUP_IPI), then it will not service a FLUSH# pin assertion until it has received the STARTUP_IPI.

Implication: After the 2-way MP initialization protocol, only one processor becomes the bootstrap processor (BSP). The other processor becomes a slave application processor (AP). After losing the BSP arbitration, the AP goes into a wait loop, waiting for a STARTUP_IPI.

The BSP can wake up the AP to perform some tasks with a STARTUP_IPI, and then put it back to sleep with an initialization inter-processor interrupt (INIT_IPI, which has the same effect as asserting INIT#), which returns it to a wait loop. The result is a possible loss of cache coherency if the off-line processor is intended to service a FLUSH# assertion at this point. The FLUSH# will be serviced as soon as the processor is awakened by a STARTUP_IPI, before any other instructions are executed. Intel has not encountered any operating systems that are affected by this erratum.

Workaround: Operating system developers should take care to execute a WBINVD instruction before the AP is taken off-line using an INIT_IPI.

Status: For the steppings affected, see the *Summary of Changes* at the beginning of this section.

C54. Double ECC Error on Read May Result in BINIT#

Problem: For this erratum to occur, the following conditions must be met:

- Machine Check Exceptions (MCEs) must be enabled.
- A dataless transaction (such as a write invalidate) must be occurring simultaneously with a transaction which returns data (a normal read).
- The read data must contain a double-bit uncorrectable ECC error.

If these conditions are met, the Celeron processor will not be able to determine which transaction was erroneous, and instead of generating an MCE, it will generate a BINIT#.

Implication: The bus will be reinitialized in this case. However, since a double-bit uncorrectable ECC error occurred on the read, the MCE handler (which is normally reached on a double-bit uncorrectable ECC error for a read) would most likely cause the same BINIT# event.

Workaround: Though the ability to drive BINIT# can be disabled in the Celeron processor, which would prevent the effects of this erratum, overall system behavior would not improve, since the error which would normally cause a BINIT# would instead cause the machine to shut down. No other workaround has been identified.

Status: For the steppings affected, see the *Summary of Changes* at the beginning of this section.

C55. MCE Due to L2 Parity Error Gives L1 MCACOD.LL

Problem: If a Cache Reply Parity (CRP) error, Cache Address Parity (CAP) error, or Cache Synchronous Error (CSER) occurs on an access to the Celeron processor's L2 cache, the resulting Machine Check Architectural Error Code (MCACOD) will be logged with '01' in the LL field. This value indicates an L1 cache error; the value should be '10', indicating an L2 cache error. Note that L2 ECC errors have the correct value of '10' logged.

Implication: An L2 cache access error, other than an ECC error, will be improperly logged as an L1 cache error in MCACOD.LL.

Workaround: None identified

Status: For the steppings affected, see the *Summary of Changes* at the beginning of this section.

C56. EFLAGS Discrepancy on a Page Fault After a Multiprocessor TLB Shutdown

Problem: This erratum may occur when the Celeron processor executes one of the following read-modify-write arithmetic instructions and a page fault occurs during the store of the memory operand: ADD, AND, BTC, BTR, BTS, CMPXCHG, DEC, INC, NEG, NOT, OR, ROL/ROR, SAL/SAR/SHL/SHR, SHLD, SHRD, SUB, XOR, and XADD. In this case, the EFLAGS value pushed onto the stack of the page fault handler may reflect the status of the register after the instruction would have completed execution rather than before it. The following conditions are required for the store to generate a page fault and call the operating system page fault handler:

1. The store address entry must be evicted from the DTLB by speculative loads from other instructions that hit the same way of the DTLB before the store has completed. DTLB eviction requires at least three-load operations that have linear address bits 15:12 equal to each other and address bits 31:16 different from each other in close physical proximity to the arithmetic operation.
2. The page table entry for the store address must have its permissions tightened during the very small window of time between the DTLB eviction and execution of the store. Examples of page permission tightening include from Present to Not Present or from Read/Write to Read Only, etc.
3. Another processor, without corresponding synchronization and TLB flush, must cause the permission change.

Implication: This scenario may only occur on a multiprocessor platform running an operating system that performs "lazy" TLB shutdowns. The memory image of the EFLAGS register on the page fault handler's stack prematurely contains the final arithmetic flag values although the instruction has not yet completed. Intel has not identified any operating systems that inspect the arithmetic portion of the EFLAGS register during a page fault nor observed this erratum in laboratory testing of software applications.

Workaround: No workaround is needed upon normal restart of the instruction, since this erratum is transparent to the faulting code and results in correct instruction behavior. Operating systems may ensure that no processor is currently accessing a page that is scheduled to have its page permissions tightened or have a page fault handler that ignores any incorrect state.

Status: For the steppings affected, see the *Summary of Changes* at the beginning of this section.



C57. Mixed Cacheability of Lock Variables Is Problematic in MP Systems

Problem: This errata only affects multiprocessor systems where a lock variable address is marked cacheable in one processor and uncacheable in any others. The processors which have it marked uncacheable may stall indefinitely when accessing the lock variable. The stall is only encountered if:

- One processor has the lock variable cached, and is attempting to execute a cache lock.
- If the processor which has that address cached has it cached in its L2 only.
- Other processors, meanwhile, issue back to back accesses to that same address on the bus.

Implication: MP systems where all processors either use cache locks or consistent locks to uncacheable space will not encounter this problem. If, however, a lock variable's cacheability varies in different processors, and several processors are all attempting to perform the lock simultaneously, an indefinite stall may be experienced by the processors which have it marked uncacheable in locking the variable (if the conditions above are satisfied). Intel has only encountered this problem in focus testing with artificially generated external events. Intel has not currently identified any commercial software which exhibits this problem.

Workaround: Follow a homogenous model for the memory type range registers (MTRRs), ensuring that all processors have the same cacheability attributes for each region of memory; do not use locks whose memory type is cacheable on one processor, and uncacheable on others. Avoid page table aliasing, which may produce a nonhomogenous memory model.

Status: For the steppings affected, see the *Summary of Changes* at the beginning of this section.

C58. INT 1 with DR7.GD set does not clear DR7.GD

Problem: If the processor's general detect enable flag is set and an explicit call is made to the interrupt procedure via the INT 1 instruction, the general detect enable flag should be cleared prior to entering the handler. As a result of this erratum, the flag is not cleared prior to entering the handler. If an access is made to the debug registers while inside of the handler, the state of the general detect enable flag will cause a second debug exception to be taken. The second debug exception clears the general detect enable flag and returns control to the handler which is now able to access the debug registers.

Implication: This erratum will generate an unexpected debug exception upon accessing the debug registers while inside of the INT 1 handler.

Workaround: Ignore the second debug exception that is taken as a result of this erratum.

Status: For the steppings affected, see the *Summary of Changes* at the beginning of this section.

C59. Potential Loss of Data Coherency During MP Data Ownership Transfer

Problem: In MP systems, processors may be sharing data in different cache lines, referenced as line A and line B in the discussion below. When this erratum occurs (with the following example given for a 2-way MP system with processors noted as 'P0' and 'P1'), P0 contains a shared copy of line B in its L1. P1 has a shared copy of Line A. Each processor must manage the necessary invalidation and snoop cycles before that processor can modify and source the results of any internal writes to the other processor.

There exists a narrow timing window when, if P1 requests a copy of line B it may be supplied by P0 in an Exclusive state which allows P1 to modify the contents of the line with no further external invalidation cycles. In this narrow window P0 may also retire instructions that use the original data present before P1 performed the modification.

Implication: Multiprocessor or threaded application synchronization, required for low level data sharing, that is implemented via operating system provided synchronization constructs are not affected by this erratum. Applications that rely upon the usage of locked semaphores rather than memory ordering are also unaffected. This erratum does not affect uniprocessor systems. The existence of this erratum was discovered during ongoing design reviews but it has not as yet been reproduced in a lab environment. Intel has not identified, to date, any commercially available application or operating system software which is affected by this erratum. If the erratum does occur one processor may execute software with the stale data that was present from the previous shared state rather than the data written more recently by another processor.

Workaround: Deterministic barriers beyond which program variables will not be modified can be achieved via the usage of locked semaphore operations. These should effectively prevent the occurrence of this erratum.

Status: For the steppings affected, see the *Summary of Changes* at the beginning of this section.

C60. Misaligned Locked Access to APIC Space Results In a Hang

Problem: When the processor's APIC space is accessed with a misaligned locked access a machine check exception is expected. However, the processor's machine check architecture is unable to handle the misaligned locked access.

Implication: If this erratum occurs the processor will hang. Typical usage models for the APIC address space do not use locked accesses. This erratum will not affect systems using such a model.

Workaround: Ensure that all accesses to APIC space are aligned.

Status: For the steppings affected, see the *Summary of Changes* at the beginning of this section.

C61. Memory Ordering Based Synchronization May Cause a Livelock Condition in MP Systems

Problem: In an MP environment, the following sequence of code (or similar code) in two processors (P0 and P1) may cause them to each enter an infinite loop (livelock condition):

<p>P0</p> <p>MOV [xyz], EAX (1)</p> <p>.</p> <p>.</p> <p>.</p> <p>MOV [abc], val1 (6)</p> <p>wait0: MOV EBX, [abc] (7)</p> <p>CMP EBX, val2 (8)</p> <p>JNE wait0 (9)</p>	<p>P1</p> <p>wait1: MOV EBX, [abc] (2)</p> <p>CMP EBX, val1 (3)</p> <p>JNE wait1 (4)</p> <p>MOV [abc], val2 (5)</p>
---	--

NOTE

The EAX and EBX can be any general-purpose register. Addresses [abc] and [xyz] can be any location in memory and must be in the same bank of the L1 cache. Variables "val1" and "val2" can be any integer.

The algorithm above involves processors P0 and P1, each of which use loops to keep them synchronized with each other. P1 is looping until instruction (6) in P0 is globally observed. Likewise, P0 will loop until instruction (5) in P1 is globally observed.

The P6 architecture allows for instructions (1) and (7) in P0 to be dispatched to the L1 cache simultaneously. If the two instructions are accessing the same memory bank in the L1 cache, the load (7) will be given higher priority and will complete, blocking instruction (1).

Instructions (8) and (9) may then execute and retire, placing the instruction pointer back to instruction (7). This is due to the condition at the end of the "wait0" loop being false. The livelock scenario can occur if the timing of the wait0 loop execution is such that instruction (7) in P0 is ready for completion every time that instruction (1) tries to complete. Instruction (7) will again have higher priority, preventing the data ([xyz]) in instruction (1) from being written to the L1 cache. This causes instruction (6) in P0 to not complete and the sequence "wait0" to loop infinitely in P0.

A livelock condition also occurs in P1 because instruction (6) in P0 does not complete (blocked by instruction (1) not completing). The problem with this scenario is that P0 should eventually allow for instruction (1) to write its data to the L1 cache. If this occurs, the data in instruction (6) will be written to memory, allowing the conditions in both loops to be true.

Implication: Both processors will be stuck in an infinite loop, leading to a hang condition. Note that if P0 receives any interrupt, the loop timing will be disrupted such that the livelock will be broken. The system timer, a keystroke, or mouse movement can provide an interrupt that will break the livelock.

Workaround: Use a LOCK instruction to force P0 to execute instruction (6) before instruction (7).

Status: For the steppings affected, see the *Summary of Changes* at the beginning of this section.

C62. Processor May Assert DRDY# on a Write With No Data

Problem: When a MASKMOVQ instruction is misaligned across a chunk boundary in a way that one chunk has a mask of all 0's, the processor will initiate two partial write transactions with one having all byte enables deasserted. Under these conditions, the expected behavior of the processor would be to perform both write transactions, but to deassert DRDY# during the transaction which has no byte enables asserted. As a result of this erratum, DRDY# is asserted even though no data is being transferred.

Implication: The implications of this erratum depend on the bus agent's ability to handle this erroneous DRDY# assertion. If a bus agent cannot handle a DRDY# assertion in this situation, or attempts to use the invalid data on the bus during this transaction, unpredictable system behavior could result.

Workaround: A system which can accept a DRDY# assertion during a write with no data will not be affected by this erratum. In addition, this erratum will not occur if the MASKMOVQ is aligned.

Status: For the steppings affected, see the *Summary of Changes* at the beginning of this section.

C63. Machine Check Exception May Occur Due to Improper Line Eviction in the IFU

Problem: The Celeron processor is designed to signal an unrecoverable Machine Check Exception (MCE) as a consistency checking mechanism. Under a complex set of circumstances involving multiple speculative branches and memory accesses there exists a one cycle long window in which the processor may signal a MCE in the Instruction Fetch Unit (IFU) because instructions previously decoded have been evicted from the IFU. The one cycle long window is opened when an opportunistic fetch receives a partial hit on a previously executed but not as yet completed store resident in the store buffer. The resulting partial hit erroneously causes the eviction of a line from the IFU at a time when the processor is expecting the line to still be present. If the MCE for this particular IFU event is disabled, execution will continue normally.

Implication: While this erratum may occur on a system with any number of Celeron processors, the probability of occurrence increases with the number of processors. If this erratum does occur, a machine check exception will result. Note systems that implement an operating system that does not enable the Machine Check Architecture will be completely unaffected by this erratum (e.g., Windows® 95 and Windows 98).

Workaround: It is possible for BIOS code to contain a workaround for this erratum.

Status: For the steppings affected, see the *Summary of Changes* at the beginning of this section.

C65. Snoop Request May Cause DBSY# Hang

Problem: A small window of time exists in which a snoop request originating from a bus agent to a processor with one or more outstanding memory transactions may cause the processor to assert DBSY# without issuing a corresponding bus transaction, causing the processor to hang (livelock). The exact circumstances are complex, and include the relative timing of internal processor functions with the snoop request from a bus agent.

Implication: This erratum may occur on a system with any number of processors. However, the probability of occurrence increases with the number of processors. If this erratum does occur, the system will hang with DBSY# asserted. At this point, the system requires a hard reset.

Workaround: It is possible for BIOS code to contain a workaround for this erratum.

Status: For the steppings affected, see the *Summary of Changes* at the beginning of this section.

C66. MASKMOVQ Instruction Interaction with String Operation May Cause Deadlock

Problem: Under the following scenario, combined with a specific alignment of internal events, the processor may enter a deadlock condition:

1. A store operation completes, leaving a write-combining (WC) buffer partially filled.
2. The target of a subsequent MASKMOVQ instruction is split across a cache line.
3. The data in (2) above results in a hit to the data in the WC buffer in (1).

Implication: If this erratum occurs, the processor deadlock condition will occur and result in a system hang. Code execution cannot continue without a system RESET.

Workaround: It is possible for BIOS code to contain a workaround for this erratum.

Status: For the steppings affected, see the *Summary of Changes* at the beginning of this section.

C67. MOVD, CVTSS2SS, or PINSRW Following Zeroing Instruction Can Cause Incorrect Result

Problem: An incorrect result may be calculated after the following circumstances occur:

1. A register has been zeroed with either a SUB reg, reg instruction, or an XOR reg, reg instruction.
2. A value is moved with sign extension into the same register's lower 16 bits; or a signed integer multiply is performed to the same register's lower 16 bits.
3. The register is then copied to an MMX™ technology register using the MOVD, or converted to single precision floating-point and moved to an MMX technology register using the CVTSS2SS instruction prior to any other operations on the sign-extended value, or inserted into an MMX™ technology register using the PINSRW instruction.

Specifically, the sign may be incorrectly extended into bits 16-31 of the MMX technology register. In the case of the PINSRW instruction, a non-zero value could be loaded into the MMX™ technology register. This erratum only affects the MMX™ technology register.

This erratum only occurs when the following three steps occur in the order shown. This erratum may occur with up to 63 (39 for Pre-CPUID 0x6BX) intervening instructions that do not modify the sign-extended value between steps 2 and 3.

1. XOR EAX, EAX
or SUB EAX, EAX
2. MOVSS AX, BL
or MOVSS AX, byte ptr <memory address> or MOVSS AX, BX
or MOVSS AX, word ptr <memory address> or IMUL BL (AX implicit, opcode F6 /5)
or IMUL byte ptr <memory address> (AX implicit, opcode F6 /5) or IMUL AX, BX (opcode 0F AF /r)

or IMUL AX, word ptr <memory address> (opcode 0F AF /r) or IMUL AX, BX, 16 (opcode 6B /r ib)
 or IMUL AX, word ptr <memory address>, 16 (opcode 6B /r ib) or IMUL AX, 8 (opcode 6B /r ib)
 or IMUL AX, BX, 1024 (opcode 69 /r iw)
 or IMUL AX, word ptr <memory address>, 1024 (opcode 69 /r iw)
 or IMUL AX, 1024 (opcode 69 /r iw) or CBW

3. MOVD MM0, EAX or CVTSS2SS MM0, EAX

Note that the values for immediate byte/words are merely representative (i.e., 8, 16, 1024) and that any value in the range for the size is affected. Also, note that this erratum may occur with “EAX” replaced with any 32-bit general-purpose register, and “AX” with the corresponding 16-bit version of that replacement. “BL” or “BX” can be replaced with any 8-bit or 16-bit general-purpose register. The CBW and IMUL (opcode F6 /5) instructions are specific to the EAX register only.

In the above example, EAX is forced to contain 0 by the XOR or SUB instructions. Since the four types of the MOVSS or IMUL instructions and the CBW instruction only modify bits 15:8 of EAX by sign extending the lower 8 bits of EAX, bits 31:16 of EAX should always contain 0. This implies that when MOVD or CVTSS2SS copies EAX to MM0, bits 31:16 of MM0 should also be 0. In certain scenarios, bits 31:16 of MM0 are not 0, but are replicas of bit 15 (the 16th bit) of AX. This is noticeable when the value in AX after the MOVSS, IMUL or CBW instruction is negative (i.e., bit 15 of AX is a 1).

When AX is positive (bit 15 of AX is 0), MOVD or CVTSS2SS will produce the correct answer. If AX is negative (bit 15 of AX is 1), MOVD or CVTSS2SS may produce the right answer or the wrong answer, depending on the point in time when the MOVD or CVTSS2SS instruction is executed in relation to the MOVSS, IMUL or CBW instruction.

The PINSRW instruction can fail to correctly load a zero when used with a partial register zeroing instruction (SUB or XOR):

1. mov di, 0FFFF8914h
2. xor eax, eax
3. add ax, di
4. xor ah, ah
5. pinsrw mm1, eax, 00h

In this case, the programmer expects mm1 to contain 0014h in its least significant word. This erratum would cause MM1 to contain 8914h. The number of intervening instructions between steps 4 and 5 is the same as noted in the sign extension example above between steps 2 and 3.

Implication: The effect of incorrect execution will vary from unnoticeable, due to the code sequence discarding the incorrect bits, to an application failure.

Workaround: There are two possible workarounds for this erratum:

1. Rather than using the MOVSS-MOVD/CVTSS2SS, IMUL-MOVD/CVTSS2SS or CBW-MOVD/CVTSS2SS pairing to handle one variable at a time, use the sign extension capabilities (PSRAW, etc.) within MMX technology for operating on multiple variables. This will also result in higher performance.
2. Insert another operation that modifies or copies the sign-extended value between the MOVSS/IMUL/CBW instruction and the MOVD or CVTSS2SS instruction as in the example below:

```
XOR EAX, EAX (or SUB EAX, EAX)
MOVSS AX, BL (or other MOVSS, other IMUL or CBW instruction)
*MOV EAX, EAX
MOVD MM0, EAX or CVTSS2SS MM0, EAX
```
3. Avoid using a sub or xor to zero a partial register prior to the use of any of these three instructions. Instead, use a mov immediate (e.g. “mov ah, 0h”).

*Note: MOV EAX, EAX is used here in a generic sense. Again, EAX can be substituted with any 32-bit register.

Status: For the steppings affected see the *Summary of Changes* at the beginning of this section.

C68. Snoop Probe During FLUSH# Could Cause L2 to be Left in Shared State.

Problem: During a L2 FLUSH operation using the FLUSH# pin, it is possible that a read request from a bus agent or other processor to a valid line will leave the line in the Shared state (S) instead of the Invalid state (I) as expected after flush operation. Before the FLUSH operation is completed, another snoop request to invalidate the line from another agent or processor could be ignored, again leaving the line in the Shared state.

Implication: Current desktop and mid range server systems have no mechanism to assert the flush pin and hence are not affected by this errata. A high end server system that does not suppress snoop traffic before the assertion of the FLUSH# pin may cause a line to be left in an incorrect cache state.

Workaround: Affected systems (those capable of asserting the FLUSH# pin) should prevent snoop activity on the front side bus until invalidation is completed after asserting FLUSH#, or use a WBINVD instruction instead of asserting the FLUSH# pin in order to flush the cache.

Status: For the steppings affected, see the *Summary of Changes* at the beginning of this section.

C69. Livelock May Occur Due to IFU Line Eviction

Problem: Following the conditions outlined for erratum C63, if the instruction that is currently being executed from the evicted line must be restarted by the IFU, and the IFU receives another partial hit on a previously executed (but not as yet completed) store that is resident in the store buffer, then a livelock may occur.

Implication: If this erratum occurs, the processor will hang in a live lock-situation, and the system will require a reset to continue normal operation.

Workaround: None identified

Status: For the steppings affected, see the *Summary of Changes* at the beginning of this section.

C70. Selector for the LTR/LLDT Register May Get Corrupted

Problem: The internal selector portion of the respective register (TR, LDTR) may get corrupted if, during a small window of LTR or LLDT system instruction execution, the following sequence of events occur:

1. Speculative write to a segment register that might follow the LTR or LLDT instruction
2. The read segment descriptor of LTR/LLDT operation spans a page (4 Kbytes) boundary; or causes a page fault

Implication: Incorrect selector for LTR, LLDT instruction could be used after a task switch.

Workaround: Software can insert a serializing instruction between the LTR or LLDT instruction and the segment register write.

Status: For the steppings affected see the *Summary of Changes* at the beginning of this section.

C71. INIT Does Not Clear Global Entries in the TLB

Problem: INIT may not flush a TLB entry when:

1. The processor is in protected mode with paging enabled and the page global enable flag is set (PGE bit of CR4 register)
2. G bit for the page table entry is set
3. TLB entry is present in TLB when INIT occurs

Implication: Software may encounter unexpected page fault or incorrect address translation due to a TLB entry erroneously left in TLB after INIT.

Workaround: Write to CR3, CR4 or CR0 registers before writing to memory early in BIOS code to clear all the global entries from TLB.

Status: For the steppings affected see the *Summary of Changes* at the beginning of this section

C72. VM Bit Will be Cleared on a Double Fault Handler

Problem: Following a task switch to a Double Fault Handler that was initiated while the processor was in virtual-8086 (VM86) mode, the VM bit will be incorrectly cleared in EFLAGS.

Implication: When the OS recovers from the double fault handler, the processor will no longer be in VM86 mode.

Workaround: None identified

Status: For the steppings affected see the *Summary of Changes* at the beginning of this section.

C73. Memory Aliasing with Inconsistent A and D bits May Cause Processor Deadlock

Problem: In the event that software implements memory aliasing by having two Page Directory Entries(PDEs) point to a common Page Table Entry(PTE) and the Accessed and Dirty bits for the two PDEs are allowed to become inconsistent, the processor may become deadlocked.

Implication: This erratum has not been observed with commercially available software.

Workaround: Software that needs to implement memory aliasing in this way should manage the consistency of the accessed and dirty bits.

Status: For the steppings affected see the *Summary of Changes* at the beginning of this section.

C74. Processor may Report Invalid TSS Fault Instead of Double Fault During Mode C Paging

Problem: When an operating system executes a task switch via a Task State Segment (TSS) the CR3 register is always updated from the new task TSS. In the mode C paging, once the CR3 is changed the processor will attempt to load the PDPTRs. If the CR3 from the target task TSS or task switch handler TSS is not valid then the new PDPTR will not be loaded. This will lead to the reporting of invalid TSS fault instead of the expected Double fault.

Implication: Operating systems that access an invalid TSS may get invalid TSS fault instead of a Double fault.

Workaround: Software needs to ensure any accessed TSS is valid.

Status: For the steppings affected see the *Summary of Changes* at the beginning of this section.

C75. APIC Failure at CPU Core/System Bus Frequency of 766/66 MHz

Problem: Operation of the Advanced Programmable Interrupt Controller (APIC) with the Celeron processor is problematic at the CPU core/system bus frequency of 766/66 MHz. With the I/O APIC enabled in BIOS, the Celeron processor may read an incorrect value from an APIC register. The Celeron processor may also randomly corrupt the vector field of an otherwise valid APIC message. The invalid vector may cause unexpected system behavior.

Implication: If this erratum occurs, the processor may hang or cause unexpected system behavior. The Celeron processor is commonly deployed on platforms with the I/O APIC option disabled. These systems are unaffected by this erratum.

Workaround: The system BIOS can disable use of the I/O APIC at the affected frequency.

Status: For the steppings affected see the *Summary of Changes* at the beginning of this section.

C76. Machine Check Exception may Occur When Interleaving Code Between Different Memory Types

Problem: A small window of opportunity exists where code fetches interleaved between different memory types may cause a machine check exception. A complex set of micro-architectural boundary conditions is required to expose this window.

Implication: Interleaved instruction fetches between different memory types may result in a machine check exception. The system may hang if machine check exceptions are disabled. Intel has not observed the occurrence of this erratum while running commercially available applications or operating systems.

Workaround: Software can avoid this erratum by placing a serializing instruction between code fetches between different memory types.

Status: For the steppings affected see the *Summary of Changes* at the beginning of this section.

C77. Wrong ESP Register Values During a Fault in VM86 Mode

Problem: At the beginning of the IRET instruction execution in VM86 mode, the lower 16 bits of the ESP register are saved as the old stack value. When a fault occurs, these 16 bits are moved into the 32-bit ESP, effectively clearing the upper 16 bits of the ESP.

Implication: This erratum has not been observed to cause any problems with commercially available software.

Workaround: None identified

Status: For the steppings affected, see the *Summary of Changes* at the beginning of this section.

C78. APIC ICR Write May Cause Interrupt Not to be Sent When ICR Delivery Bit Pending

Problem: If the APIC ICR (Interrupt Control Register) is written with a new interrupt command while the Delivery Status bit from a previous interrupt command is set to '1' (Send Pending), the interrupt message may not be sent out by the processor.

Implication: This erratum will cause an interrupt message not to be sent, potentially resulting in system hang.

Workaround: Software should always poll the Delivery Status bit in the APIC ICR and ensure that it is '0' (Idle) before writing a new value to the ICR.

Status: For the steppings affected, see the *Summary of Changes* at the beginning of this section.

C79. The instruction Fetch Unit (IFU) May Fetch Instructions Based Upon Stale CR3 Data After a Write to CR3 Register

Problem: Under a complex set of conditions, there exists a one clock window following a write to the CR3 register where-in it is possible for the iTLB fill buffer to obtain a stale page translation based on the stale CR3 data. This stale translation will persist until the next write to the CR3 register, the next page fault or execution of a certain class of instructions including RDTSC, CPUID, or IRETD with privilege level change.

Implication: The wrong page translation could be used leading to erroneous software behavior.

Workaround: Operating systems that are potentially affected can add a second write to the CR3 register.

Status: For the stepping affected see the *Summary of Changes* at the beginning of this section.

C80. The Processor Might not Exit Sleep State Properly Upon De-assertion of CPUSLP# Signal

Problem: If the processor enters a sleep state upon assertion of CPUSLP# signal, and if the core to system bus multiplier is an odd bus fraction, then the processor may not resume from the CPU sleep state upon the de-assertion of CPUSLP# signal.

Implication: This erratum may result in a system hang during a resume from CPU sleep state.

Workaround: It is possible to workaround this in BIOS by not asserting CPUSLP# for power management purposes.

Status: For the stepping affected see the *Summary of Changes* at the beginning of this section.

C81. During Boundary Scan, BCLK not Sampled High When SLP# is Asserted Low

Problem: During boundary scan, BCLK is not sampled high when SLP# is asserted low.

Implication: Boundary scan results may be incorrect when SLP# is asserted low.

Workaround: Do not use boundary scan when SLP# is asserted low.

Status: For the steppings affected, see the *Summary of Changes* at the beginning of this section.

C82. Incorrect Assertion of THERMTRIP# Signal

Problem: The internal control register bit responsible for operation of the Thermtrip circuit functionality may power up in a non-initialized state. As a result, THERMTRIP# may be incorrectly asserted during de-assertion of RESET# at nominal operating temperatures. When THERMTRIP# is asserted as a result of this erratum, the processor may shut down internally and stop execution but in few cases continue to execute.

Implication: This issue can lead to intermittent system power-on boot failures. The occurrence and repeatability of failures is system dependent, however all systems and processors are susceptible to failure. In addition, the processor may fail to stop execution during the event of a valid THERMTRIP# assertion resulting in the potential for permanent processor damage.

Workaround: To prevent the risk of power-on boot failures or catastrophic thermal failures, a platform workaround is required. The system must provide a rising edge on the TCK signal during the power-on sequence that meets all of the following requirements:

- Rising edge occurs after Vcc_core is valid and stable
- Rising edge occurs before or at the de-assertion of RESET#
- Rising edge occurs after all Vref input signals are at valid voltage levels
- TCK input meets the Vih min and max spec as mentioned In EMTS

Specific workaround implementations may be platform specific. The following examples have been tested as acceptable workaround implementations.

Please note, the example workaround circuits attached require circuit modification for ITP tools to function correctly. These modifications must remove the workaround circuitry from the platform and may cause systems to fail to boot. Review the accompanying notes with each workaround for ITP modification details. If the system fails to boot when using ITP, issuing the ITP 'Reset Target' command on failing systems will reset the system and provide a sufficient rising edge on the TCK pin to ensure proper system boot.

In addition, the example workaround circuits shown do not support production motherboard test methodologies that require the use of the processor JTAG/TAP port. Alternative workaround solutions must be found if such test capability is required.

Figure 1 Celeron® on 0.13 Micron Processor 256K Platforms Workaround

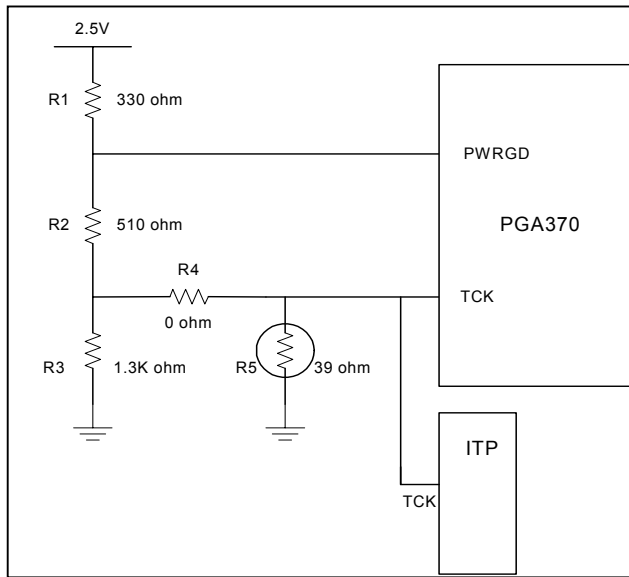

For Production Boards:
Depopulate R5

To use ITP:
Install R5, Depopulate R4

- The example workaround circuit assumes that the PWRGD inputs into the processors are open collector. Tying the PWRGD inputs together in a Wired-AND fashion allows each processor to receive PWRGD at the same time but at the latter of the 2 separate PWRGD assertions. If separation of the PWRGD inputs to each processor is required, extra circuitry will be required.

Status: For the steppings affected, see the Summary of Changes at the beginning of this section.

C83. Under Some Complex Conditions, the Instructions in the shadow of a JMP FAR may be Unintentionally Executed and Retired

Problem: If all of the following events happen in sequence it is possible for the system or application to hang or to execute with incorrect data.

1. The execution of an instruction, with an OPCODE that requires the processor to stall the issue of micro-instructions in the flow from the microcode sequence logic block to the instruction decode block (a StallMS condition).
2. Less than 63 (39 for Pre-CPUID 0x6BX) micro-instructions later, the execution of a mispredictable branch instruction (Jcc, LOOPcc, RET Near, CALL Near Indirect, JMP ECX=0, or JMP Near Indirect).
3. The conditional branch in event (2) is mispredicted, and furthermore the mispredicted path of execution must result in either an ITLB miss, or an Instruction Cache miss. This needs to briefly stall the issue of micro-instructions again immediately after the conditional branch until that branch prediction is corrected by the jump execution block (a 2nd StallMS condition).
4. Along the correct path of execution, the next instruction must contain a 3rd StallMS condition at a precisely aligned point in the execution of the instruction (CLTS, POPSS, LSS, or MOV to SS).
5. A JMP FAR instruction must execute within the next 63 micro-instructions (39 Pre-CPUID 0x6BX). The intervening micro-instructions must not have any events or faults.

When the instruction from event (2) retires, the StallMS condition within the event (5) instruction fails to operate correctly, and instructions in the shadow of the JMP FAR instruction could be unintentionally executed.

Implication: Occurrence of this erratum could lead to erroneous software behavior. Intel has not identified any commercial software which may encounter this condition; this erratum was discovered in a focused test environment. One of the four instructions that are required to trigger this erratum, CLTS, is a privileged instruction that is only executed by an operating system or driver code. The remaining three instructions, POPSS, LSS, and MOV to SS, are executed infrequently in modern 32-bit application code.

Workaround: None identified at this time.

Status: For the stepping affected see the *Summary of Changes* at the beginning of this section.

C84. Processor Does not Flag #GP on Non-zero Write to Certain MSRs

Problem: When a non-zero write occurs to the upper 32 bits of SYSENTER_EIP_MSR or SYSENTER_ESP_MSR, the processor should indicate a general protection fault by flagging #GP. Due to this erratum, the processor does not flag #GP.

Implication: The processor unexpectedly does not flag #GP on a non-zero write to the upper 32 bits of SYSENTER_EIP_MSR or SYSENTER_ESP_MSR. No known commercially available operating system has been identified to be affected by this erratum.

Workaround: None identified.

Status: For the steppings affected see the *Summary of Changes* at the beginning of this section.

C1AP APIC Access to Cacheable Memory Causes SHUTDOWN

Problem: APIC operations which access memory with any type other than uncacheable (UC) are illegal. If an APIC operation to a memory type other than UC occurs and Machine Check Exceptions (MCEs) are disabled, the processor will enter SHUTDOWN after such an access. If MCEs are enabled, an MCE will occur. However, in this circumstance, a second MCE will be signaled. The second MCE signal will cause the Celeron processor to enter SHUTDOWN.

Implication: Recovery from a PIC access to cacheable memory will not be successful. Software that accesses only UC type memory during APIC operations will not encounter this erratum.

Workaround: Ensure that the memory space to which PIC accesses can be made is marked as type UC (uncacheable) in the memory type range registers (MTRRs) to avoid this erratum.

Status: For the steppings affected see the *Summary of Changes* at the beginning of this section.

C2AP Write to Mask LVT (Programmed as EXTINT) Will Not Deassert Outstanding Interrupt

Problem: If the APIC subsystem is configured in Virtual Wire Mode implemented through the local APIC (i.e., the 8259 INTR signal is connected to LINT0 and LVT1's interrupt delivery mode field is programmed as EXTINT), a write to LVT1 intended to mask interrupts will not deassert the internal interrupt source if the external LINT0 signal is already asserted. The interrupt will be erroneously posted to the Celeron processor despite the attempt to mask it via the LVT.

Implication: Because of the masking attempt, interrupts may be generated when the system software expects no interrupts to be posted.

Workaround: Software can issue a write to the 8259A interrupt mask register to deassert the LINT0 interrupt level, followed by a read to the controller to ensure that the LINT0 signal has been deasserted. Once this is ensured, software may then issue the write to mask LVT entry 1.

Status: For the steppings affected see the *Summary of Changes* at the beginning of this section.

C3AP Misaligned Locked Access to APIC Space Results in Hang

Problem: When the processor's APIC space is accessed with a misaligned locked access a machine check exception is expected. However, the processor's machine check architecture is unable to handle the misaligned locked access.

Implication: If this erratum occurs the processor will hang. Typical usage models for the APIC address space do not use locked accesses. Systems using such a model will not be affected by this erratum.

Workaround: Ensure that all accesses to APIC space are aligned and/or not locked.

Status: For the steppings affected see the *Summary of Changes* at the beginning of this section.



This page is intentionally left blank.



DOCUMENTATION CHANGES

The Documentation Changes listed in this section apply to the following documents:

- *Pentium® II Processor Developer's Manual*
- *P6 Family of Processors Hardware Developer's Manual*
- *Intel® Celeron® Processor Datasheet*
- *Intel Architecture Software Developer's Manual, Volumes 1, 2, and 3*

All Documentation Changes will be incorporated into a future version of the appropriate Celeron processor documentation.

C1. SSE and SSE2 Instructions Opcodes

The note at the end of section 2.2 in the *Intel Architecture Software Developer's Manual, Vol 2: Instruction Set Reference* states:

NOTE:

Some of the SSE and SSE2 instructions have three-byte opcodes. For these three-byte opcodes, the third opcode byte may be F2H, F3H, or 66H. For example, the SSE2 instruction CVTQ2PD has the three-byte opcode F3 OF E6. The third opcode byte of these three-byte opcodes should not be thought of as a prefix, even though it has the same encoding as the operand size prefix (66H) or one of the repeat prefixes (F2H and F3H). As described above, using the operand size and repeat prefixes with SSE and SSE2 instructions is reserved.

It should state:

NOTE:

Some of the SSE and SSE2 instructions have three-byte opcodes. For these three-byte opcodes, the third opcode byte may be F2H, F3H, or 66H. For example, the SSE2 instruction CVTQ2PD has the three-byte opcode F3 OF E6. The third opcode byte of these three-byte opcodes should not be thought of as a prefix, even though it has the same encoding as the operand size prefix (66H) or one of the repeat prefixes (F2H and F3H). As described above, using the operand size and repeat prefixes with SSE and SSE2 instructions is reserved. It should also be noted that execution of SSE2 instructions on an Intel processor that does not support SSE2 (CPUID Feature flag register EDX bit 26 is clear) will result in unpredictable code execution.

C2. Executing the SSE2 Variant on a Non-SSE2 Capable Processor

In *Intel Architecture Software Developer's Manual, Vol 2: Instruction Set Reference* the section for each of the following instructions states that executing the instruction in real or protected mode on a processor for which the SSE2 feature flag returned by CPUID is 0 (SSE2 not supported by the processor) will result in the generation of an undefined opcode exception (#UD). This is incorrect. The SSE2 form of these instructions is defined by opcodes for which the leading opcode byte maps into an operand size prefix. Executing the SSE2 variant of these instructions on a non-SSE2 capable processor will result in an SSE like operation and not a #UD. Refer to section 2.2 of the *Intel Architecture Software Developer's Manual, Vol 2* for more detail.

Instructions:

MOVD xmm, r32; MOVD r32, xmm; MOVDQA; MOVDQU; MOVQ xmm, m64; PACKSSWB/DW;
PACKUSWB; PADDB/W/D; PADDDB/W; PADDUSB/W; PAND; PANDN; PCMPEQB/W/D; PCMPGTB/W/D;
PMADDWD; PMULHW; PMULLW; POR; PSLW/D/Q; PSRAW/D; PSRLW/D/Q; PSUBB/W/D; PSUBSB/W;
PSUBUSB/W; PUNPCKHBW/W/D/DQ; PUNPCKLBW/W/D/DQ; PXOR.

C3. Direction Flag (DF) Mistakenly Denoted as a System Flag

The *Intel Architecture Software Developer's Manual, Vol 1: Basic Architecture* Section 3.4.3 "EFLAGS Register", in Figure 3-7. EFLAGS Register currently states:

X Direction Flag(DF)

It should state:

C Direction Flag(DF)

C4. Fopcode Compatibility Mode

The *Intel Architecture Software Developer's Manual, Vol 1: Basic Architecture* Section 8.1.8.1 "FOPCODE COMPATIBILITY MODE" currently states:

"When the FOP code compatibility mode is enabled, the IA32 architecture guarantees that if an unmasked x87 FPU floating-point exception is generated, the opcode of the last non-control instruction executed prior to the generation of the exception will be stored in the x87 FPU opcode register, and that value can be read by a subsequent FSAVE or FXSAVE instruction. When the fop compatibility mode is disabled (default), the value stored in the x87 FPU opcode register is undefined (reserved)."

It should state:

"If FOP code compatibility mode is enabled, the FOP is defined as it has always been in previous IA32 implementations (always defined as the FOP of the last non-transparent FP instruction executed before a FSAVE/STENV/FXSAVE).

If FOP code compatibility mode is disabled (default), FOP is only valid if the last non-transparent FP instruction executed before a FSAVE/STENV/FXSAVE had an unmasked exception."

C5. FCOS, FPTAN, FSIN, and FSINCOS Trigonometric Domain
NOT correct.

The *Intel Architecture Software Developer's Manual, Vol 2: Instruction Set Reference* Section 3.2 "INSTRUCTION REFERENCE" FCOS, FPTAN, FSIN, and FSINCOS trigonometric domain for C2 is incorrect. Under the FPU Flags affected, C2 currently states:

C2 Set to 1 if source operand is outside the range -2^{63} to $+2^{63}$; otherwise, cleared to 0.

It should state:

C2 Set to 1 if outside range $-2^{63} < \text{source operand} < +2^{63}$; otherwise, set to 0.

C6. Incorrect Description of stack

The *IA-32 Intel Architecture Software Developer's Manual, Volume 1: Basic Architecture* Chapter 6, Section 6.2 paragraph 2, labeled "STACK" currently states:

The next available memory location on the stack is called the top of stack. At any given time, the stack pointer (contained in the ESP register) gives the address (that is the offset from the base of the SS segment) of the top of the stack.

This paragraph is incorrect and will be removed from the section listed above.

C7. EFLAGS Register Correction

The *Intel Architecture Software Developer's Manual, Volume 1: Basic Architecture* Section 3.7.2, Figure 3.7. "EFLAGS Register" currently states:

Bit 11 "OF" as "X"

It should state:

Bit 11 "OF" as "S"

C8. PSE-36 Paging Mechanism

The *Intel Architecture Software Developer's Manual, Vol 3: System Programming Guide* Chapter 3, Section 3.9, third paragraph currently states:

As is shown in Table 3-3, the following flags must be set or cleared to enable the PSE-36 paging mechanism:

- PSE-36 CPUID feature flag-When set, it indicates the availability of the PSE-36 paging mechanism on the IA-32 processor on which the CPUID instruction is executed.
- PG flag (bit 31) in register CR0-Set to 1 to enable paging.
- PSE flag (bit 4) in control register CR4 - Set to 1 to enable the page size extension for 4-Mbyte pages.
- PAE flag (bit 5) in control register CR4-Clear to 0 to disable the PAE paging mechanism.

It should state:

As is shown in Table 3-3, the following flags must be set or cleared to enable the PSE-36 paging mechanism:

- PSE-36 CPUID feature flag-When set, it indicates the availability of the PSE-36 paging mechanism on the IA-32 processor on which the CPUID instruction is executed.
- PG flag (bit 31) in register CR0-Set to 1 to enable paging.
- PAE flag (bit 5) in control register CR4-Clear to 0 to disable the PAE paging mechanism.
- PSE flag (bit 4) in control register CR4 and the PS flag in PDE- Set to 1 to enable the page size extension for 4-Mbyte pages.
- Or the PSE flag (bit 4) in control register CR4- Set to 1 and the PS flag (bit 7) in PDE- Set to 0 to enable 4-KByte pages with 32-bit addressing (below 4GBytes).

C9. 0x33 Opcode

The *Intel Architecture Software Developer's Manual, Vol 2: Instruction Set Reference* Appendix A, Table A-2, the opcode corresponding to 0x33 currently states:

Gb, Ev

It should state:

Gv, Ev

Also, Page 3-791, XOR-Logical Exclusive OR, the two entries for opcode 33 currently state:

Opcode	Instruction	Description
33 /r	XOR r16,r/m16	r8 XOR r/m8
33 /r	XOR r32,r/m32	r8 XOR r/m8

It should state:

	Opcode	Instruction	Description
	33 /r	r16 XOR r/m16	r8 XOR r/m8
	33 /r	r32 XOR r/m32	r8 XOR r/m8

C10. Incorrect Information for SLDT

In the *Intel Architecture Software Developer's Manual, Vol 2: Instruction Set Reference*, the opcode/Instruction/Description table for SLDT currently states "SLDT r/m32 Store segment selector from LDTR in low-order 16 bits of r/m32" but should instead list "SLDT r32 Store segment selector from LDTR in low-order 16 bits of r32."

C11. LGDT/LIDT Instruction Information Correction

In the *Intel Architecture Software Developer's Manual, Vol 2: Instruction Set Reference*, the sentence in the LGDT/LIDT instruction section currently states:

"See 'SFENCE -- Store Fence' in this chapter for information on storing the contents of the GDTR and IDTR."

It should state:

"See 'SGDT/SIDT' in this chapter for information on storing the contents of the GDTR and IDTR."

C12. Errors in Instruction Set Reference

The following changes will be made to the *Intel Architecture Software Developer's Manual, Vol 2: Instruction Set Reference*:

1. Page 3-586 "PMULUDQ—Multiply Packed Unsigned Doubleword Integers" currently states:

66 OF F4 /r PMULUDQ xmm1, xmm2/m128

It should state:

66 0F F4 /r PMULUDQ xmm1, xmm2/m128

2. Page A-9, Table A-3, Two-byte Opcode Map:08H-7FH (First Byte is 0FH), entry 2B currently states:

MOVNTPS
Wps, Vps
MOVNTPS (66)
Wpd, Vpd

It should state:

MOVNTPS
Wps, Vps
MOVNTPD (66)
Wpd, Vpd

3. Page A-9, Table A-3, Two-byte Opcode Map:08H-7FH (First Byte is 0FH). Entry 3C currently states:

Blank (empty space)

It should state:

MOVNTI

4. Page A-10, Table A-3, Two-byte Opcode Map:80H-7FH (First Byte is 0FH). Entry D7 currently states:

PMOVMSKB
Gd, Pq
PMOVMSKB (66)
Gd, Vdq

It should state:

PMOVMSKB
Gd, Pq

PMOVMSKB (66)
Gd, Vdq

5. *Page A-10, Table A-3, Two-byte Opcode Map:80H-7FH (First Byte is 0FH).*
Entry F7 currently states:

MASKMOVQ
Ppi, Qpi
MASKMOVQU (66)
Vdq, Wdq

It should state:

MASKMOVQ
Ppi, Qpi
MASKMOVDQU (66)
Vdq, Wdq

6. *Page A-11, Table A-3, Two-byte Opcode Map:88H-7FH (First Byte is 0FH).*
The title table currently states:

Table A-3. Two-byte Opcode Map:88H-7FH (First Byte is FFH)

It should state:

Table A-3. Two-byte Opcode Map:88H-7FH (First Byte is 0FH)

7. *Page A-11, Table A-3, Two-byte Opcode Map:88H-7FH (First Byte is 0FH).*
Entry FB currently states:

PSUBD
Pq, Qq
PSUBD (66)
Vdq, Wdq

It should state:

PSUBQ
Pq, Qq
PSUBQ (66)
Vdq, Wdq

8. *Page B-21, Table B-12, MMX Instruction Formats and Encodings (Contd.).*
Entry PMADD currently states:

PMADD – Packed Multiply add

It should state:

PMADDWD – Packed Multiply add

9. *Page B-21, Table B-12, MMX Instruction Formats and Encodings (Contd.).*
Entry PMULH currently states:

PMULH – Packed multiplication

It should state:

PMULHW – Packed multiplication, store high word

10. *Page B-21, Table B-12, MMX Instruction Formats and Encodings (Contd.)*.
Add instruction PMULHUW :

PMULHUW – Packed multiplication, store high word (unsigned)

mmxreg2 to mmxreg1	0000 1111: 1110 0100: 11	mmxreg1 mmxreg2
memory to mmxreg	0000 1111: 1110 0100: mod	mmxreg r/m

11. *Page B-21, Table B-12, MMX Instruction Formats and Encodings (Contd.)*.
Entry PMULL currently states:

PMULL – Packed multiplication

It should state:

PMULLW – Packed multiplication, store low word

12. *Page B-40, Table B-19, Formats and Encodings of the SSE2 SIMD Integer Instruction*.
Entry PMADD currently states:

PMADD – Packed multiply add

It should state:

PMADDWD – Packed multiply add

13. *Page B-41, Table B-19, Formats and Encodings of the SSE2 SIMD Integer Instruction*.
Entry PMULH currently states:

PMULH – Packed multiplication

It should state:

PMULHW – Packed multiplication, store high word

14. *Page B-41, Table B-19, Formats and Encodings of the SSE2 SIMD Integer Instruction*.
Add instruction PMULHUW:

PMULHUW – Packed multiplication, store high word (unsigned)

xmmreg2 to xmmreg1	0110 0110 : 0000 1111 : 11110 0100 : 11	xmmreg1 xmmreg2
memory to xmmreg	0110 0110 : 0000 1111 : 1110 0100 : mod	xmmreg r/m

15. Page B-41, Table B-19, *Formats and Encodings of the SSE2 SIMD Integer Instruction*.
Entry PMULL currently states:

PMULL – Packed multiplication

It should state:

PMULLW – Packed multiplication, store low word

C13. RSM Instruction Set Summary

The *Intel Architecture Software Developer's Manual, Vol 1: Basic Architecture* Section 5.8 "INSTRUCTION SET SUMMARY" currently states:

RSM Return from system management mode (SSM)

It should state:

RSM Return from system management mode (SMM)

C14. Correct MOVAPS and MOVAPD Operand Section

The *Intel Architecture Software Developer's Manual, Vol 2: Instruction Set Reference* Section 3.2 "INSTRUCTION REFERENCE" MOVAPS and MOVAPD operation section currently states:

Operation

DEST ← SRC;

It should state:

Operation

DEST ← SRC;

- #GP if SRC or DEST unaligned memory operand *;

C15. DAA—Decimal Adjust AL after Addition

The *Intel Architecture Software Developer's Manual, Vol 2: Instruction Set Reference* page 3-173 currently states:

Operation

```

IF (((AL AND 0FH) > 9) or AF = 1)
  THEN
    AL ← AL + 6;
    CF ← CF OR CarryFromLastAddition; (* CF OR carry from AL ← AL + 6 *)
    AF ← 1;
  ELSE
    AF ← 0;
FI;
IF ((AL AND F0H) > 90H) or CF = 1)
  THEN
    AL ← AL + 60H;
    CF ← 1;
  ELSE
    CF ← 0;
FI;

```

It should state:

Operation

```

old_AL ← AL;
old_CF ← CF;
CF ← 0;
IF (((AL AND 0FH) > 9) or AF = 1)
  THEN
    AL ← AL + 6;
    CF ← old_CF or (Carry from AL ← AL + 6);
    AF ← 1;
  ELSE
    AF ← 0;
FI;
IF ((old_AL > 99H) or (old_CF = 1))
  THEN
    AL ← AL + 60H;
    CF ← 1;
  ELSE
    CF ← 0;
FI;

```

C16. DAS—Decimal Adjust AL after Subtraction

The *Intel Architecture Software Developer's Manual, Vol 2: Instruction Set Reference*, on page 3-175 currently states:

Operation

```
IF (AL AND 0FH) > 9 OR AF = 1
  THEN
    AL ← AL - 6;
    CF ← CF OR CarryFromLastAddition; (* CF OR carry from AL ← AL - 6 *)
    AF ← 1;
  ELSE AF ← 0;
FI;
IF ((AL > 9FH) or CF = 1)
  THEN
    AL ← AL - 60H;
    CF ← 1;
  ELSE CF ← 0;
FI;
```

It should state:

Operation

```
old_AL ← AL;
old_CF ← CF;
CF ← 0;
IF (((AL AND 0FH) > 9) or AF = 1)
  THEN
    AL ← AL - 6;
    CF ← old_CF or (Borrow from AL ← AL - 6);
    AF ← 1;
  ELSE
    AF ← 0;
FI;
IF ((old_AL > 99H) OR (old_CF = 1))
  THEN
    AL ← AL - 60H;
    CF ← 1;
  ELSE
    CF ← 0;
FI;
```

C17. Omission of Dependency Between BTM and LBR

The *Intel Architecture Software Developer's Manual, Vol 3: System Programming Guide* Chapter 15, Section 5.3, on page 15-15 currently states:

15.5.3. Monitoring Branches, Exceptions, and Interrupts (Pentium 4 and Intel Xeon Processors)

When the LBR flag in the IA32_DEBUGCTL MSR is set, the processor automatically begins recording branch records for taken branches, interrupts, and exceptions (except for debug exceptions) in the LBR stack MSRs.

When the processor generates a debug exception (#DB), it automatically clears the LBR flag before executing the exception handler, but does not touch the LBR stack MSRs. The branch records for the last four taken branches, interrupts, and/or exceptions are thus retained for analysis by the debugger program.

The debugger can use the linear addresses in the LBR stack to reset breakpoints in the break-point-address registers (DR0 through DR3), allowing a backward trace from the manifestation of a particular bug toward its source.

Before resuming program execution from a debug-exception handler, the handler must set the LBR flag again to re-enable last branch recording.

It should state:

15.5.3. Monitoring Branches, Exceptions, and Interrupts (Pentium 4 and Intel Xeon Processors)

When the LBR flag in the IA32_DEBUGCTL MSR is set, the processor automatically begins recording branch records for taken branches, interrupts, and exceptions (except for debug exceptions) in the LBR stack MSRs.

When the processor generates a debug exception (#DB), it automatically clears the LBR flag before executing the exception handler. This action does not clear previously stored LBR stack MSRs. The branch record for the last four taken branches, interrupts and/or exceptions are retained for analysis.

A debugger can use the linear addresses in the LBR stack to reset breakpoints in the break-point address registers (DR0 through DR3). This allows a backward trace from the manifestation of a particular bug toward its source.

If the LBR flag is cleared and TR flag in the IA32_DEBUGCTLTR MSR remains set, the processor will continue to update LBR stack MSRs. This is because BTM information must be generated from entries in the LBR stack (see 14.5.5). A #DB does not automatically clear the TR flag.

C18. I/O Permissions Bitmap Base Addy > 0xDFFF Does not Cause #GP(0) Fault

The *Intel Architecture Software Developer's Manual, Vol 1: Basic Architecture*, page 12-6, section 12.5.2, last paragraph currently states:

If the I/O bit map base address is greater than or equal to the TSS segment limit, there is no I/O permission map, and all I/O instructions generate exceptions when the CPL is greater than the current IOPL. The I/O bit map base address must be less than or equal to DFFFH.

It should state:

If the I/O bit map base address is greater than or equal to the TSS segment limit, there is no I/O permission map, and all I/O instructions generate exceptions when the CPL is greater than the current IOPL.

C19. Wrong Field Width for MINSS and MAXSS

The *Intel Architecture Software Developer's Manual, Vol 2: Instruction Set Reference Section 3.2 Instruction Reference* under "MAXSS—Return Maximum Scalar Single-Precision Floating-Point Value" page 3-415 currently states:

DEST[63-0] .IF ((DEST[31-0] = 0.0) AND (SRC[31-0] = 0.0)) THEN SRC[31-0]

It should state:

DEST[31-0] .IF ((DEST[31-0] = 0.0) AND (SRC[31-0] = 0.0)) THEN SRC[31-0]

The *Intel Architecture Software Developer's Manual, Vol 2 Section 3.2 Instruction Reference* under title "MINSS—Return Minimum Scalar Single-Precision floating-Point Value" page 3-428 currently states:

DEST[63-0] .IF ((DEST[31-0] = 0.0) AND (SRC[31-0] = 0.0)) THEN SRC[31-0]

It should state:

DEST[31-0] .IF ((DEST[31-0] = 0.0) AND (SRC[31-0] = 0.0)) THEN SRC[31-0]

C20. Figure 15-12 PEBS Record Format

The *Intel Architecture Software Developer's Manual, Vol 3: System Programming Guide* Section 15.9.6 "Programming the Performance Counters for Non-Retirement Events" page 15 - 37, Figure 15-12, first row currently states:



It should state:

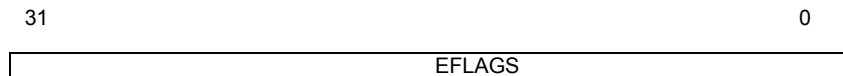

C21. I/O Permission Bit Map

The *Intel Architecture Software Developer's Manual, Vol 1: Basic Architecture* Chapter 12, section 12.5.2 on Figure 12-2 (I/O Permission Bit Map) currently states:

Last byte of bit map must be followed by a byte with all bits.

It should state:

Last byte of bit map must be followed by a byte with all bits set.

Also, in the lower left hand Conner of Figure 12-2 (I/O Permission Bit Map) currently states:

Last I/O base map must be

It should state:

Last I/O base map must be less than or equal to DFFFH

C22. Cache Description

The *Intel Architecture Software Developer's Manual, Vol 2: Instruction Set Reference* Table 3-10, the "sectored, 64 byte line size" description is used for the following descriptors: 0x22, 0x23, 0x79, 0x7a, 0x7b, 0x7c. This description will change to "dual-sectored line, 64 byte sector size" for clarity.

C23. Instruction Formats and Encoding

The *Intel Architecture Software Developer's Manual, Vol 2: Instruction Set Reference* Page B-8, CMOVcc memory to register should be encoded as "0000 1111 : 0100 tttt : mod reg r/m". Page B-8, CMP immediate with memory should be encoded as "1000 00sw : mod 111 r/m : immediate data". Page B-12 POP "segment register CS, DS, ES" should be encoded as "segment register DS, ES".

C24. Machine-Check Initialization

The *Intel Architecture Software Developer's Manual, Vol 3: System Programming Guide* section 14.5 currently states:

14.5 MACHINE-CHECK INITIALIZATION

To use the processors machine-check architecture, software must initialize the processor to activate the machine-check exception and the error-reporting mechanism.

Example gives pseudocode for performing this initialization. This pseudocode checks for the existence of the machine-check architecture and exception on the processor, then enables the machine-check exception and the error-reporting register banks. The pseudocode assumes that the machine-check exception (#MC) handler has been installed on the system. This initialization procedure is compatible with the Pentium 4, Intel Xeon, P6 family, and Pentium processors.

Following power up or power cycling, the IA32_MCi_STATUS registers are not guaranteed to have valid data until after the registers are initially cleared to all 0s by software, as shown in the initialization pseudocode in Example .

Machine-Check Initialization Pseudocode

```
EXECUTE the CPUID instruction;  
READ bits 7 (MCE) and 14 (MCA) of the EDX register;
```



```

IF CPU supports MCE
  THEN
    IF CPU supports MCA
      THEN
        IF IA32_MCG_CAP.MCG_CTL_P = 1
          (* IA32_MCG_CTL register is present *)
            IA32_MCG_CTL FFFFFFFF;
            (* enables all MCA features *)
          FI;
          COUNT <-- IA32_MCG_CAP.Count;
          MAX_BANK_NUMBER <-- COUNT - 1;
          (* determine number of error-reporting banks supported *)
          IF (P6 Family Processor)
            THEN
              FOR error-reporting banks (1 through MAX_BANK_NUMBER) DO
                IA32_MCj_CTL <-- FFFFFFFF;
                (* enables logging of all errors except for MC0_CTL register *)
              OD
              ELSE (* Pentium 4 and Intel Xeon Processors *)
                FOR error-reporting banks (0 through MAX_BANK_NUMBER) DO
                  IA32_MCj_CTL <-- FFFFFFFF;
                  (* enables logging of all errors including MC0_CTL register *)
                OD
              FI;
              FOR error-reporting banks (0 through MAX_BANK_NUMBER) DO
                IA32_MCj_STATUS <-- 0000000000000000H; (* clears all errors *)
              OD
            FI;
          Set the MCE flag (bit 6) in CR4 register to enable machine-check exceptions;
        FI;

```

It should state:

14.5 MACHINE-CHECK INITIALIZATION

To use the processors machine-check architecture, software must initialize the processor to activate the machine-check exception and the error-reporting mechanism.

Example gives pseudocode for performing this initialization. This pseudocode checks for the existence of the machine-check architecture and exception on the processor, then enables the machine-check exception and the error-reporting register banks. The pseudocode shown is compatible with the Pentium 4, Intel Xeon, P6 family, and Pentium processors.

Following power up or power cycling, the IA32_MCj_STATUS registers are not guaranteed to have valid data until after the registers are initially cleared to all 0s by software, as shown in the initialization pseudocode in



Example . In addition, when using P6 family processors, the software must set MCI_STATUS registers to 0 when doing a soft-reset.

Machine-Check Initialization Pseudocode

```
Check CPUID Feature Flags for MCE and MCA support
IF CPU supports MCE
THEN
  IF CPU supports MCA
  THEN
    IF (IA32_MCG_CAP.MCG_CTL_P = 1)
    (* IA32_MCG_CTL register is present *)
    THEN
      IA32_MCG_CTL <-- FFFFFFFFFFFFFFFFH;
      (* enables all MCA features *)
    FI

    (* Determine number of error-reporting banks supported *)
    COUNT<-- IA32_MCG_CAP.Count;
    MAX_BANK_NUMBER <-- COUNT - 1;

    IF (Processor Family is 6H)
    THEN
      (* Enable logging of all errors except for MC0_CTL register *)
      FOR error-reporting banks (1 through MAX_BANK_NUMBER)
      DO
        IA32_MCi_CTL <-- 0FFFFFFFFFFFFFFFH;
      OD

      (* Clear all errors *)
      FOR error-reporting banks (0 through MAX_BANK_NUMBER)
      DO
        IA32_MCi_STATUS <-- 0;
      OD

    ELSE IF (Processor Family is 0FH) (*any Processor Extended Family *)
    THEN
      (* Enable logging of all errors including MC0_CTL register *)
      FOR error-reporting banks (0 through MAX_BANK_NUMBER)
      DO
        IA32_MCi_CTL <-- 0FFFFFFFFFFFFFFFH;
      OD

      (* BIOS clears all errors only on power-on reset *)
      IF (BIOS detects Power-on reset)
      THEN
```



```
FOR error-reporting banks (0 through MAX_BANK_NUMBER)
DO
    IA32_MCi_STATUS <-- 0;
OD
ELSE
FOR error-reporting banks (0 through MAX_BANK_NUMBER)
DO
    (Optional for BIOS and OS) Log valid errors
    (OS only) IA32_MCi_STATUS <-- 0;
OD
FI
FI
```

Setup the Machine Check Exception (#MC) handler for vector 18 in IDT

Set the MCE bit (bit 6) in CR4 register to enable Machine-Check Exceptions

FI



This page is intentionally left blank.

SPECIFICATION CLARIFICATIONS

The Specification Clarifications listed in this section apply to the following documents:

- *Pentium® II Processor Developer's Manual*
- *P6 Family of Processors Hardware Developer's Manual*
- *Intel® Celeron® Processor Datasheet*
- *Intel Architecture Software Developer's Manual, Volumes 1, 2, and 3*

All Specification Clarifications will be incorporated into a future version of the appropriate Celeron processor documentation.

C1. PWRGOOD Inactive Pulse Width

In Table 16 of the *Intel® Celeron® Processor Datasheet*, footnote 9 should read as follows:

9. When driven inactive or after V_{CCORE} , V_{CCL2} , and BCLK become stable. PWRGOOD must remain below $V_{IL,max}$ from Table 8 until all the voltage planes meet the voltage tolerance specifications in Table 6 and BCLK has met the BCLK AC specifications in Table 11 for at least 10 clock cycles. PWRGOOD must rise glitch-free and monotonically to 2.5 V.

C2. Floating-Point Opcode Clarification

Section 3.2 of the *Intel Architecture Software Developer's Manual, Volume 2: Instruction Set Reference*, provides detailed descriptions of each Intel Architecture instruction. For some instructions, the clarification phrase below needs to either be added to their existing "Comments" section or a "Comments" section needs to be created with the clarification phrase. The phrase is as follows:

The (**Instruction** shown in the center column of the table below) instruction is actually a combination of two instructions - the FWAIT instruction followed by (**Instruction** shown in the table). If the (**Instruction** shown in the table) instruction should fault in some way (e.g., page fault), the value of EIP that is passed to the fault handler will be equal to the EIP of the first instruction plus one (i.e., the EIP of the second of the pair of instructions). The FWAIT portion of the combined instruction will have completed execution and will typically not be, nor need to be, re-executed after the fault handler is completed.

The following table lists the affected instructions and the location of the clarification phrase:

Instruction Set Reference Section	Opcode	Instruction	Addition	Addition to Page
FCLEX/FNCLEX-Clear Exceptions	9B DB E2	FCLEX	Add "Comments" section with clarification phrase	3-177
FINIT/FNINIT-Initialize Floating-Point Unit	9B DB E3	FINIT	Add clarification phrase to existing "Comments" section	3-204
FSAVE/FNSAVE-Store FPU	9B DD /6	FSAVE	Add clarification	3-237

Instruction Set Reference Section	Opcode	Instruction	Addition	Addition to Page
State		m94/108byte	phrase to existing "Comments" section	
FSTCW/FNSTCW-Store Control Word	9B D9 /7	FSTCW m2byte	Add "Comments" section with clarification phrase	3-250
FSTENV/FNSTENV-Store FPU Environment	9B D9 /6	FSTENV m14/28byte	Add "Comments" section with clarification phrase	3-253
FSTSW/FNSTSW-Store Status Word	9B DD /7	FSTSW m2byte	Add "Comments" section with clarification phrase	3-256
	9B DF E0	FSTSW AX		

C3. MTRR Initialization Clarification

The following sentence should be added to the end of the first paragraph of Section 9.12.5 of the *Intel Architecture Software Developer's Manual*, Volume 3: System Programming Guide: "The MTRRs must be disabled prior to initialization or modification."

C4. Non-AGTL+ Output Low Current Clarification

In Table 6 of the *Intel® Celeron® Processor Datasheet*, the note in **bold** should be added:

Symbol	Parameter	Min	Max	Unit	Notes
V _{IL}	Input Low Voltage	-0.3	0.7	V	
V _{IH}	Input High Voltage	1.7	2.625	V	2.5 V +5% maximum
V _{OL}	Output Low Voltage		0.4	V	2
V _{OH}	Output High Voltage	N/A	2.625	V	All outputs are open-drain to 2.5 V +5%
I _{OL}	Output Low Current	14		mA	5
I _L	Leakage Current for Inputs, Outputs, and I/O		±100	µA	3, 4

Notes:

1. Unless otherwise noted, all specifications in this table apply to all Celeron processor frequencies.
2. Parameter measured at 14 mA (for use with TTL inputs).
3. (0 ≤ V_{IN} ≤ 2.5 V +5%).
4. (0 ≤ V_{OUT} ≤ 2.5 V +5%).
5. **Specified as the minimum amount of current that the output buffer must be able to sink. However, VOL_MAX cannot be guaranteed if this specification is exceeded.**

SPECIFICATION CHANGES

The Specification Changes listed in this section apply to the following documents:

- *Pentium® II Processor Developer's Manual*
- *P6 Family of Processors Hardware Developer's Manual*
- *Intel® Celeron® Processor Datasheet*
- *Intel Architecture Software Developer's Manual, Volumes 1, 2, and 3*

All Specification Changes will be incorporated into a future version of the appropriate Celeron processor documentation.

C1. RESET# Pin Definition

The *P6 Family of Processors Hardware Developer's Manual*, the *Pentium® II Processor Developer's Manual*, and the *Intel® Celeron® Processor Datasheet* have incorrect definitions of the RESET# pin in their alphabetical signal listings. These documents incorrectly state:

RESET# must remain active for one microsecond for a 'warm' Reset; for a Power-on Reset, RESET# must stay active for at least one millisecond after V_{CCCORE} and CLK have reached their proper specifications.

They should state:

For a Power-on or "warm" reset, RESET# must stay active for at least one millisecond after V_{CCCORE} and CLK have reached their proper specifications.

C2. Tco max revision for 533A, 566 & 600 MHz

The Tco_max specification for the Coppermine-128K processors **533A, 566 & 600 MHz** is being revised from 3.25ns to 4.05ns. This specification change only effects the Coppermine-128K operating at 1.5V. The Coppermine-128K operating at 1.65V will continue with the Tco_max specification of 3.25ns. The next revisions of the *Intel® Celeron® Specification Update* and datasheet will be updated to reflect this change. Intel has verified that flexible motherboard designs which follow Intel's recommended layout guidelines will not be impacted by these new specifications. For customers who have designs aimed to support **ONLY** the Coppermine-128K processors 533A, 566 & 600 MHz, Intel recommends to verify that the new 4.05ns Tco_max spec remains within the particular design's guidelines.

C3. Processor Thermal Specification Change and TDP Redefined

The Thermal Design Power (TDP) for Celeron processors has been redefined. Table 2 details TDP for Celeron processors. The updated TDP values are based on device characterization and do not reflect any silicon design changes to lower processor power consumption. Absolute power consumption has not changed; however, the max thermal design power specifications are being updated to reflect actual silicon performance. The TDP values represent the thermal design point required to cool Celeron processors in the platform environment. This replaces column 3 and column 4, Processor Power and Processor Core Power, from Table 37 of the *Intel® Celeron® Processor Datasheet*.

Additional derating of the thermal design power and design requirements will result in a processor Tj max temperature specification violation and will affect proper functionality of the processor. Operation of a processor outside of the specifications will result in undetermined behavior that may result in immediate system failure or degradation of the processor's functional lifetime. Note that the TDP specifications are **thermal design requirements only** and do not reflect voltage regulation or power delivery specification changes.

**Table 2. Update to Table 37 of the
*Intel® Celeron® Processor Datasheet***

Frequency (MHz)	Tj_max (°C)	TDP (W)	Tj Offset (C)
533	90	11.2	1.6
566	90	11.9	1.7
600	90	12.6	1.8
633	82	16.5	2.4
667	82	17.5	2.5
700	80	18.3	2.7